

The Magazine for LEGO® Enthusiasts!



\$8.95
in the US

Brick Journal

Issue 6, Volume 2 • Summer 2009

people • building • community

SPACE!

LEGO Space Sets,
Old and New

Brandon Griith's
STAR TREK Models

BrickFest 2009

Reality Check

Reviews

Instructions

AND MORE!



Brick Journal

people • building • community

THE ULTIMATE MAGAZINE FOR LEGO™ ENTHUSIASTS OF ALL AGES!

BRICKJOURNAL magazine (edited by Joe Meno) spotlights all aspects of the LEGO Community, showcasing events, people, and models every issue, with contributions and how-to articles by top builders worldwide, new product intros, and more. Edited by JOE MENO. Begun as a digital-only publication in 2005, the NEW PRINT VERSION (Vol. 2) of BrickJournal launched in 2008, and is available in both print and digital form. PLUS: Print subscribers get the digital version FREE!



BRICKJOURNAL #1 (Vol. 2)

The ultimate resource for LEGO enthusiasts of all ages, showcasing events, people, and models! FULL-COLOR #1 features an interview with set designer and LEGO Certified Professional NATHAN SAWAYA, plus step-by-step building instructions and techniques for all skill levels, new set reviews, on-the-scene reports from LEGO community events, and other surprises!

(80-page FULL COLOR magazine) \$8.95 US
(Digital Edition) \$3.95 (or FREE to print customers)



BRICKJOURNAL #2 (Vol. 2)

This FULL-COLOR issue spotlights blockbuster summer movies, LEGO style! Go behind the scenes for new sets for BATMAN and INDIANA JONES, and see new models, including an SR-71 SPYPLANE and a LEGO CITY, plus MINIFIGURE CUSTOMIZATIONS, BUILDING INSTRUCTIONS, tour the ONLINE LEGO FACTORY, and more!

(80-page FULL COLOR magazine) \$8.95 US
(Digital Edition) \$3.95 (or FREE to print customers)



BRICKJOURNAL #3 (Vol. 2)

Event Reports from BRICKWORLD, FIRST LEGO LEAGUE WORLD FESTIVAL and PIECE OF PEACE (Japan), spotlight on our cover model builder BRYCE MCGLOONE, and interviews with ARTHUR GUGICK and STEVEN CANVIN of LEGO MINDSTORMS to see where LEGO ROBOTICS is going! There's also STEP-BY-STEP BUILDING INSTRUCTIONS, TECHNIQUES, & more!

(80-page FULL COLOR magazine) \$8.95 US
(Digital Edition) \$3.95 (or FREE to print customers)



BRICKJOURNAL #4 (Vol. 2)

Interviews with LEGO BUILDERS including BREANN SLEDGE (BIONICLE BUILDER), Event Reports from BRICKFAIR and BRICKCON, plus reports on new MINDSTORMS PROJECTS, STEP-BY-STEP BUILDING INSTRUCTIONS and TECHNIQUES for all skill levels, NEW SET REVIEWS, and a report on constructing the Chinese Olympic Village in LEGO!

(80-page FULL COLOR magazine) \$8.95 US
(Digital Edition) \$3.95 (or FREE to print customers)



DIGITAL EDITIONS AVAILABLE FOR ONLY \$3.95 PER DOWNLOAD

NEXT ISSUE: BRICKJOURNAL #7 (Vol. 2)

FULL-COLOR issue #7 focuses on LEGO ARCHITECTURE, with a look at the new sets designed by ADAM REED TUCKER! There's also interviews with other architectural builders, including SPENCER REZHALLA and JASON BURIK. Then, we take a look at a LEGO BATTLESHIP that's over 20 feet long, and present event reports from BRICKWORLD in Chicago and other events worldwide! PLUS: Our usual indispensable building tips and instructions, and more, so watch for issue #7 in August, as BRICKJOURNAL GOES BI-MONTHLY!

(80-page FULL COLOR magazine) \$8.95 US
(Digital Edition) \$3.95 (or FREE to print subscribers)
Ships August 2009!



BRICKJOURNAL #5 (Vol. 2)

FULL-COLOR issue #5 features event reports from around the world, and the MINDSTORMS 10TH ANNIVERSARY at LEGO HEADQUARTERS! Plus an interview with the head of the LEGO GROUP'S 3D DEPARTMENT, a glimpse at the LEGO GROUP'S PAST with the DIRECTOR OF LEGO'S IDEA HOUSE, instructions and spotlights on builders, and an idea section for PIRATE BUILDERS!

(80-page FULL COLOR magazine) \$8.95 US
(Digital Edition) \$3.95 (or FREE to print customers)
Now shipping!



4-ISSUE SUBSCRIPTIONS: \$38 US Postpaid by Media Mail
(\$48 First Class, \$55 Canada • Elsewhere: \$78 Surface, \$85 Airmail)
NEW! DIGITAL SUBSCRIPTIONS: \$15.80 for four digital issues

PRINT SUBSCRIBERS GET THE DIGITAL EDITION FREE, BEFORE THE PRINT ISSUE HITS STORES!



TwoMorrows. Celebrating The Art & History Of LEGO.™ (& Comics!)

TwoMorrows • 10407 Bedfordtown Drive • Raleigh, NC 27614 USA • 919-449-0344 • FAX: 919-449-0327 • E-mail: twomorrow@aol.com • www.twomorrows.com

Brick Journal

Issue 6, Volume 2 • Summer 2009
people • building • community

Contents

From the Editor 2

News and Events

Taking a Reality Check 3

Building the Tallest Tower (Japan) 6

Discover KAUST 2009 8

People

Adult Female Fans of LEGO (AFFOL)

Regina Mateos Rodilla 10

Yoshikazu Saito: Parts Specialist 13

The Brick-Paved Road to the Model Shop 17

Brandon on the Edge of Forever 21

Building

Creating the New Space Police 27

Character Building: Creating Aliens 35

The TRUTH about SPACE! 38

You Can Build It

MINI Space Cruiser 44

LEGO Pirates: A Review 46

LEGO Power Functions Train Development:

On Track with LEGO Fans 54

Emerald Night: A Designer's Perspective 59

The Mighty Hood 60

Minifigure Customization 101:

Casting Parts in Resin Plastic 65

Miniland Figure Building: The Toddler 68

Got SNOT? 70

Community

Confessions of a BrickFest® Virgin 72

Building the DUPLO Brand 76

Last Word 79

AFOLs 80



Summer 2009

Volume 2, Issue 6

Editor in Chief

Joe Meno

Photography Editor

Geoff Gray

Business Manager and Proofreader

Carin Proctor

Copy Editor

Allan Bedford

Proofreader

Eric Nolen-Weathington

European Bureau Editor

Megan Rothrock

Japanese Bureau Editor

Nathan Bryan

West Coast Editors

Todd Kubo, Ashley Glennon

Layout Artists

Didier Enjary, Tommy Williamson

Contributors:

Joe Meno, Joseph Williams, Pam Wall, Tomoko Tamura, Regina Mateos Rodilla, Nathan Bryan, Tommy Williamson, Richard Kaponas, Ellen Wang, Hadley Scrowston, Mark Stafford, Niels Milan Pedersen, Christopher Deck, Geoff Gray, Megan Rothrock, Gaute Munch, Ed Diment, Jared Burks, Didier Enjary, Scott Lyttle, Jennifer Wagner, John Langrish, Chris Wunz, Bill Ward, Inge Aaen, Jette Orduna and Greg Hyland.

Many thanks to the websites who have served as mirrors for *BrickJournal*:

www.lugnet.com

www.Brickshelf.com

www.peeron.com

www.brickmodder.net

www.rustyclank.com

About the Cover:

A model by Mark Stafford for the initial cover design. Art by Mark Stafford.



From the Editor:

This issue was planned out about six months ago. By then there was an interest in making a space-themed issue, and there were rumors of something coming from the LEGO Group in a space theme.

We found out for sure in February with the Space Police, and with that, we were able to start asking for information on the new sets. The result was far better than I hoped for: we have interviews with the LEGO

set designers about the sets and the minifigures designs. To take a look at the past, we got an interview with one of the Classic Space set designers and also obtained some photos from some of the ideas that were considered for space. On the fan side, there's an interview with Brandon Griffith, who built some spaceships from *Star Trek* — the classic show.

From the LEGO Group, we also got reports on the new Emerald Night set and the Power Functions elements for train use and also the first of a two-part look at the DUPLO line of LEGO products.

In the community, we have reports on BrickFest, Japanese LEGO builder Yoshikazu Saito, and thanks to Nathan Bryan of our new Japan Bureau, instructions on SNOT and Miniland building!

Funny thing is, for this space issue, we ran out of space! So we are going bi-monthly starting next issue....so there will be more stories, more photos, and more fun!

Joe Meno, editor

P.S. Have ideas or comments? Drop me a line at admin@brickjournal.com. Or go to www.lugnet.com and leave a comment on their forums! I'm open to suggestions and comments and will do my best to reply.

P.P.S. Yes, *BrickJournal* has a website — www.brickjournal.com! You can check out the news there or look at the event calendar and see what is happening near you!

P.P.P.S. *BrickJournal Compendiums 1 and 2 are 50% off through July 31! If you ever wanted the issues of BrickJournal that were online before it went to print, you can get them now — CHEAP! Go to twomorrows.com to find out more!*

Glossary

AFOL (Adult Fan of LEGO)

NLSO (Non-LEGO Significant Other)

MOC (My Own Creation)

TLG (The LEGO Group)

BURP (Big Ugly Rock Piece)

LURP (Little Ugly Rock Piece)

POOP (Pieces—that can be or should be made—Of Other Pieces)

SNOT (Studs Not on Top)

LUG (LEGO Users Group)

LTC (LEGO Train Group)

LEGO®, TECHNIC, MINDSTORMS, Belville, Scala, BIONICLE, ExoForce, Mars Mission, World City, and other LEGO theme lines are trademarks of the LEGO Group of companies. All articles, photos, and art are copyright BrickJournal Media, LLC 2008, TwoMorrows Publishing and the respective writers, photographers, and artists. All rights reserved. All trademarked items are the property of their respective owners and licensees. Subscriptions are \$38USD Media Mail, \$55 Canada, \$78 International Surface, \$85 International Airmail from www.twomorrows.com or payment sent to: TwoMorrows Publishing, 10407 Bedfordtown Drive, Raleigh, NC 27614 USA. The editorial/advertising office address for BrickJournal is: BrickJournal Editor, 5600 Oak Meadow Lane #1108, Raleigh, NC 27612 USA or admin@brickjournal.com. First Printing. Printed in USA. ISSN 1941-2347.

BrickJournal and its staff would like to thank the LDraw community for the software it makes available to the community, which we use for making all of the instructions and renderings in this magazine. We would especially like to thank Kevin Clague for his continued upgrades of the LPub tool that is a part of the LDraw suite. For more information, please visit <http://www.ldraw.org>.

Taking a Reality Check



For many LEGO builders, building a city is a minor challenge. Rounding up parts and using baseplates to create the land for a metropolitan area can get expensive and take a little time, but city making can be done with some planning. However, urban planners who are responsible for planning the growth of real cities have a much larger challenge. There are many more factors in 'real life' to deal with that are much more complex, including transit, water, and density and sprawl . Balancing growth and resources in a wise manner is something that takes more than LEGO building...or does it?



In 2002, the Urban Land Institute developed a way to plan the projected job and household growth of a metropolitan region using a medium that allowed for collaboration and easy understanding among many participants. What was the medium? LEGO bricks. The process, called Reality Check, was first used in Los Angeles in fall 2002, and has been used in Washington, DC, North Texas, Maryland, and other areas. "This exercise allows participants to throw out their preconceived notions about how land is zoned today and forget what type of growth they believe is coming tomorrow, said Pam Wall, executive director of Triangle Tomorrow, the organization that hosted the event in partnership with ULI Triangle. "The exercise is amazingly powerful and as the LEGO brick stacks grow taller, people grasp their responsibility in the region's future."

On February 24, 2009, the Research Triangle region of North Carolina was the setting for a Reality Check exercise. Almost 300 people representing a 15-county region, from academics and civic leaders to government officials and everything inbetween, met at the Raleigh Convention Center and broke up into teams of ten for this one day exercise.

Each team was placed at a table with a regional map scaled to LEGO bricks. Projections for the year 2030 were given using LEGO bricks to represent 1.2 million new residents (800 yellow 2 x 2 bricks) and 700,000 jobs (368 red 2 x 2 bricks) a total of 1168 LEGO brick per table. Purple, orange and green yarn was also used to represent transit, roads or green space (such as parks or greenways). Essentially, Reality Check became a game using the map as the game board and the LEGO bricks and yarn being playing pieces.

There's a bit of serious thought that has to be done before playing, though. The teams had to develop a set of guiding principles for quality growth to follow throughout the exercise. To get to this point, each team has to gather a consensus – which requires discussion and debate.

Once the developing principles were worked out, the pieces were placed and reviewed and adjusted. The map quickly took on a look of a bar game, but instead of military formations, cities were being defined. Stacks of yellow and red bricks created a mini-hi-rise on one map, while another map was composed of lower, almost rolling piles of bricks. Some maps had active road and transit systems in the yarn that was woven between the brick, some had greenways zoned off with green yarn.

To help the teams envision what the Triangle Region looks like now, a regional map was built out in LEGO bricks to show the current population and jobs. This LEGO brick map was also on display the month before the exercise at The Research Triangle Park Headquarters. "The minute people entered our building they went immediately to the LEGO map display. They were fascinated by it and it sparked quite a few discussions about our innovate way to map growth in our region, explained Rick Weddle, President & CEO of The Park and event co-chair. "And, oh yes those LEGO bricks are fun!"



For many, this was a great opportunity to understand the challenges faced by the Research triangle area in the next two decades. With the bricks and yarn, everyone could have a hands-on experience in planning the community, which led to more discussion as new problems showed themselves. Bricks shifted, and yarn moved as alternatives were discussed and tried. Thirty tables, as the day went on, became thirty different proposals to develop the region.

Although each of the 28 tables has a unique map and LEGO placement, there were three common themes and strategies that emerged. They can be described as Compact (taller LEGO stacks), Clustered (mini-city centers on transit corridors), and Dispersed (lower LEGO stacks in outlying areas). A couple of days later, a public presentation based on the insights and plans made by all the teams was given at Meymandi Concert Hall in Raleigh. The presentations were interspersed with skits by a local improv team, with one of the most memorable lines from a small boy asking his mother, "Mom, tell me the story again about the people who played with LEGOs a long time ago so I could have the best place to live."

The LEGO bricks, over 8,000 of them, are on a celebrity Reality Check tour. They have been borrowed from the Triangle Region by Reality Check events in Jacksonville, Florida, and Central Region South Carolina. Pam Wall says she is looking forward to getting her LEGO bricks back in the next couple of weeks. "I actually miss having them in the big plastic bags in my office. They have become kind of a status symbol!" And yes, she locks them up each and every night. 



LEGO Records

Tallest Tower

*Article and Photography
by LEGO Japan*

Building the Tallest Tower

On April 3rd, 2009, Japan broke the Guinness World Records for erecting the world's tallest toy-brick tower at 29.70 metres, under difficult weather conditions, with hard work and fantastic Kids' support.

This was the first time this event was held in Japan. We were so excited and worked hard to design the tower as a signature of Japanese creativity. We have great PR and TV programming planned and we were well supported by our AFOL (Adult Fans of LEGO). They contributed some unique beautiful Japanese design sections for our tower and we were very proud to present our tower to the rest of the world.

It was fine and sunny day when we started (March 31st). The tower was built at Nasu Highland Park, which is located in a resort area outside of Tokyo. Children of visitors of this park gathered to build the tower. They were also excited to build and contribute to each part of the tower. Some special sections were designed by our AFOL, so the children were happy and eager to participate. On the first day, the first Art section "Sea" almost finished.

And so to the second day. The weather turned to rain and cold, so we had to move the main building area for children and their families indoors. Somehow we managed to continue to build the tower, but we were behind of schedule. You could only just see the sign of "LEGO Tower 2009 Japan" on the side of the Tower.

On the third day, it snowed in the early morning! You could see white snow everywhere, and the first job for MC (LEGO) builders was to clear it away. However, the scenery was beautiful once the sky cleared. The colourful LEGO Tower with the snow-capped mountain behind stood out under blue clear sky. Children, AFOL and MC (LEGO) builders now focussed on building each part of tower for the final day.

The final day was a beautiful day for celebrating the breaking of the Guinness World Records. The MC (LEGO) builders were still busy building up each parts of tower, which the children had built the day before. You could now see the second Art section

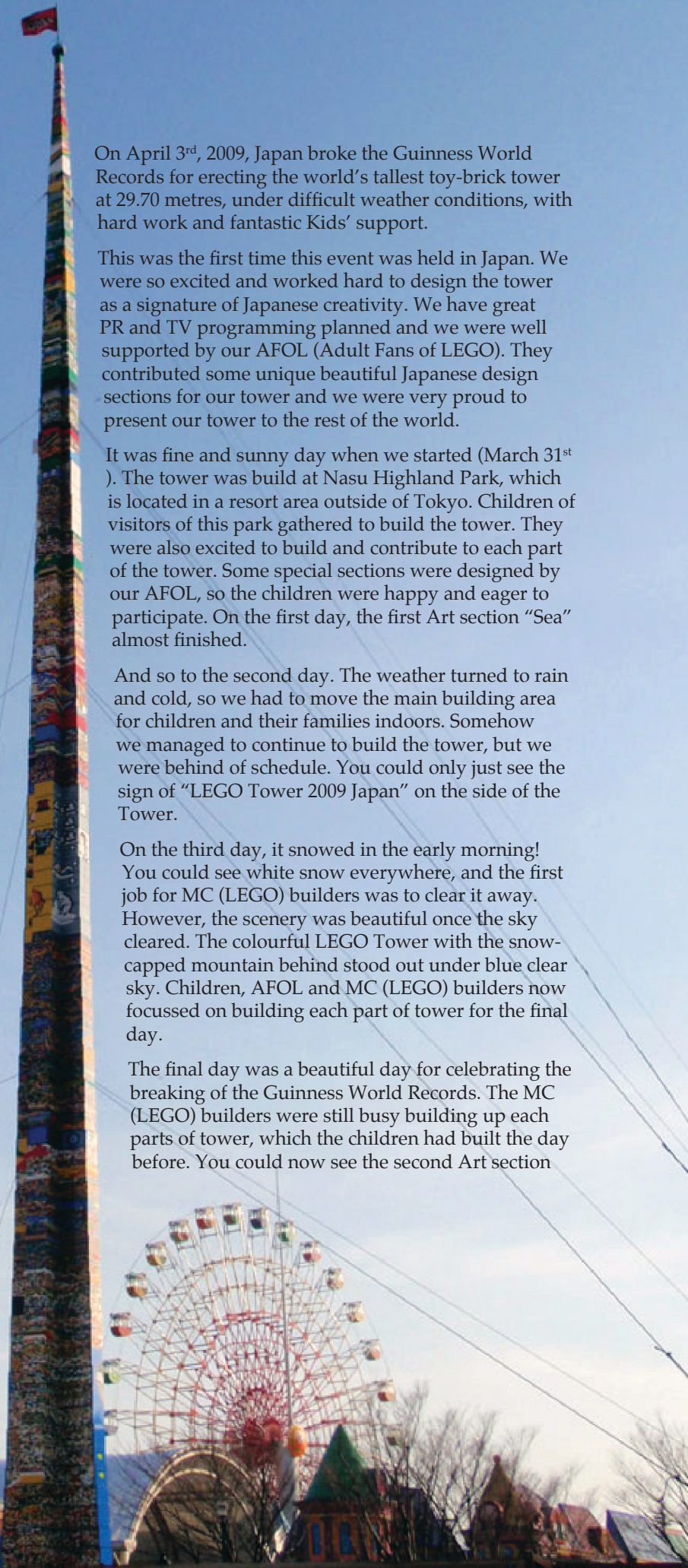

“Earth”. Children were also busy building the final 5m section of tower at the main building area. Finally the exciting moment arrived. You could see the sign of “LOVE & PEACE” and the Art section “Sky”. MC (LEGO) builders invited one of the AFOLs, who designed final part of the Tower “Globe”, onto the crane for honour of placing the final part on the top of the Tower. Later the staff of Guinness World Records confirmed the official heights as a fantastic 29.7meters.

We are very proud of our accomplishment under difficult circumstances although the beautiful blue sky highlighting our colourful LEGO Tower was a just reward all our hard work. This four day event was recorded for a TV program which will be on the air on April 29th, at the beginning of Golden Week in Japan. We also expect that many kids who could not participate on this event will watch and share our excitement. 🇯🇵



Event

Discover KAUST 2009

*Article and Photography
by Joe Meno*



January was the beginning to the new year and also the beginning for some 300 graduate students to study at the King Abdullah University of Science and Technology (KAUST). Coming from all points of the globe, the students would be working at the new campus, located by Thuwal, Saudi Arabia. With so many different cultures meeting together, communication was expected to be a big challenge. To introduce the students to KAUST, the faculty, and to each other, an orientation event was created.

Discover KAUST, as it was called, was a week-long session where the students learned everything about the new college (which was still under construction to meet its Fall 2009 opening date) and the setting from culture to people. And the students also were able to work together and begin building their own community, with the use of LEGO bricks and elements.

The idea of using LEGO building as a means to team building led to having a group of facilitators familiar with LEGO SERIOUS PLAY and MINDSTORMS building becoming the initial workshops to Discover KAUST. The facilitators had been brought together from as many places as the students came from, with members from the US, Canada, Germany, Sweden, Taiwan, Egypt, and France. Led by the Dubai based group Disruptive Play FZ LLC, a group which specializes in collaborative innovation programs and business transformational change. Disruptive Play worked with Strategic Play (based in Germany), and Brixplay (based in Taiwan) as well as Bashar al Safadi (based in Egypt) to co-innovate and develop the program for the first set of scholarship students at KAUST. Other co-developers included key LEGO community / Mindstorms members. Over the two days the facilitators the students were devoted to building and creating a student community for the first set of scholarship students starting at KAUST University in September 2009.

The community building began with the students placed into teams and, led by Jens Hoffmann of Strategic Play, proceeded with the team members building LEGO models to represent themselves, their ideal teammate and what **each individual** would contribute to their **team during the two day workshop**. From there, the teams created a group model, with the team members building and writing about how their community could service society. While the models were challenging to think about, the students all were creative in their models and bonded while building the group model, with groups getting more and more animated in their discussions and building. Building was punctuated by comments and laughs as teams built different models and items. With a common goal, the teams began to bond, regardless of language and culture, and by the end of the day, each table had a **shared model, a shared language and shared view of the world**.

The next day, the challenge changed significantly – instead of building with LEGO bricks, MINDSTORMS sets were on each team's tables, and instead of building models that were symbolic, the challenge was to make a functioning module/ engineering solution which would allow over hundred ping pong balls to move through an infinity loop track on the floor.

Leading this challenge was Eugene Tsai, from Brixplay. The modules were to be designed to a size constraint and be able to deliver ping-pong balls from one end to the other to be picked up by the next module. The path followed by the balls would follow an infinity sign when completed by all the teams.

However, building with MINDSTORMS elements is different from building with LEGO bricks, so a very quick tutorial was done to show how the NXT brick worked with other components.

The teams also became tighter-knit, with Eugene encouraging them to create cheers and team logos / values which became part of their team's motto going forward. Before long, what started only a day before as a quiet workshop became a loud center of activity, with the teams cheering themselves and each other and doing a human wave on the floor map of the infinity sign.

The MINDSTORMS parts were not the only things used to build modules. Cardboard, tape, straws and even chairs were used! The floor space for the modules was eventually covered with the models built by the teams, and the wall screens kept a countdown for each phase of the challenge, from design to testing and joining with other modules.

The large room began to buzz with the chatter of teams and the motors of the MINDSTORMS sets during testing. There were as many module designs as there were teams, with many different solutions to moving the ping-pong balls. One module had a car push the balls with a paddle. Another had an arm that spun to push balls away. Still another threw a ball to the top of a slope, which moved the ball to the next module.

The teams started to talk to each other to figure out how to join modules, which took the team building to a community building level. Adjustments were discussed and made, and by the end, many of the modules were working together. Success was not complete, though, mainly because a few non-showing teams left some holes in the infinity sign that could not be patched. Some of the teams also had some technical issues, but the success was in the community building, as everyone joined in and worked on getting the modules running! There was also another interesting effect that happened as the modules were getting completed...people came to see the creations. The student advisors and some faculty dropped in to see what was going and were impressed by the models.

Afterwards, there was a final session devoted to evaluating the lessons learned. Bashar Al Safadi of Omniegypt was the host of this session, where the teams discussed what they learned from all of their activities. From their discussions, the top points were determined and presented to all of the teams. And through all the differences the students had when they first met, they found they had a lot in common – and they all had learned to communicate and have fun with each other.

After the session ended, many of the students took pictures with their new classmates and now friends, but one team took some of the ping-pong balls they used and signed them as a group, as a keepsake of their first meeting. At Discover KAUST, the students discovered more than a college.

They discovered a community. 



AFFOLs: Adult Female Fans of LEGO



Regina Mateos Rodilla

*Edited by Megan Rothrock
Photography provided
by Regina Mateos Rodilla*

Age: 25

Country: Spain

Brickshelf Gallery:

<http://guide.lugnet.com/set/mlist.cgi?m=3428>

What hobbies do you have?

I have lots of hobbies aside LEGO of course, going to the Flea Markets and discovering old LEGO is very fun! Aside collecting LEGO I also collect coffee makers. I love fashion, to travel a lot, and Cinema is a passion as well. I studied Film as part of my degree in University.

How long have you been building or collecting LEGO?

My first set was a Fabuland set when I was four years old. It was a van that came from a small bookshop that had a lot of educational learning books. My parents found that I was very interested with LEGO, so whenever I had to do something scary like going to the Dentist or Dr's I got a small LEGO set as a reward! From a very early age I am very careful with my LEGO boxes, not to crush or damage them in anyway.

What percentage of your spare time do you spend building with LEGO?

That's a bit tricky since I'm not a prolific builder, more of a collector that builds.

When I was 5 or 6 years old I would role-play with my LEGO boxes, which were closed and unopened. Playing a sales woman, or store owner was great fun for me, I finally got brave and one day opened a box! I loved seeing all of the colors and shapes, and continued to play shop, setting out the pieces like they were for sale. This allowed me to have my own little LEGO Shop!

No matter what I was doing, LEGO was always in my life. At the age of 16 I enjoyed collecting mostly, and building up my own archive! I am an only child so I had to entertain myself, LEGO was something special to have and cherish. As my collection grew, I found LEGO as a way of booking time for myself. I acquired two rooms in the house just for my LEGO Collection, an advantage to being an only child.

Around the age of 17 -18 my father who is an architect gave me one of his old drafting tables and I built up some sets, and used other things around the house to help make back grounds to create displays for my friends and family to see.

What is your favorite LEGO theme?

The Café Corner, Green Grocer, and Market Street are some of my favorites. I love the old Adventures line and all of Castle too.

For my collection I do it by Theme, so if I get one of say Star wars, then I have to have them all in that line!

What is it that inspires you about LEGO products?

LEGO is great! It has endless bricks, but also constraints at the same time. Something like a LEGO Creator set is nice, it gives you three examples and that inspires you to try and build things on your own.

If you could design any new parts what would they be?
1x3 and a 1x5 tile.

I'd also like to see more colors, turquoise, a different



purple, and more colors in the dark colors series (dark red, blue ect)

How is it being a female in the AFOL community?

It's FANTASTIC!!! They treat me like a Princess, and respect for me. I'm not very active in the wider AFOL community; I tend to keep to myself.

I have really enjoyed meeting and sharing time with the LEGO Designers they have all been so nice.

Can you think of any ways to encourage other girls to build with LEGO?

I think LEGO should focus more on role-playing particularly in Europe. Girls love a good challenge, if we could provide them with the tools do so, they would love it. Something like 'how would you build your own dolls' house'?

The new LEGO CITY Farm set is cool, and it should appeal to girls! I consider myself to be a 'girly girl' and love pink, but a LEGO set doesn't need to be ALL pink.

How relevant do you find the products LEGO makes that are aimed at girls?

From a business perspective, sets like Belville do well so I guess LEGO is doing extremely well right now.





“Girls love a good challenge, if we could provide them with the tools do so, they would love it. Something like ‘how would you build your own dolls’ house’? ”

Do you have any other comments you would like to share?

For the past year and a half I have been lucky enough to work for LEGO in Billund Denmark!!!

My road to LEGO has been a fairy tale adventure. I needed sometime for myself and wanted to travel. From my family, I got as a gift for completing my degree a trip to take the LEGO Inside Tour in Billund!! It was such an amazing time, and while I was there I met Camilla (need job title/name) she was very nice to me, and we hit it off.

I went back to Spain to finish my degree that June. I qualified for a grant from the Spanish Government to

have your first working experience from Abroad. I'd kept up contact with Camilla and I was hired as a trainee for Public Relations and Events. Then after a year I was hired into the New Business Group (six months ago).

(NBG is a department within the LEGO Group that has been working in collaboration with both private individuals and other LEGO departments, since 2006. It is a hothouse for nurturing wide-range business ideas projecting the LEGO brick into a whole new series of markets aiming for brand-new target groups. It combines the brick –and its LEGO core values- is combined with innovative business thinking.)

It has been great for me! To be part of P.R. side allowed me to stay close the LEGO Fan Community and fans. The New Business side has allowed me to get much closer to the inner workings of the company.

While working at LEGO I have been allowed to learn about other parts of the company like LEGO Education, and see just how important LEGO can be used as a learning tool. I have an even deeper interest for the company's history. I also admire how well LEGO has embraced the online world, with projects like LEGO Factory and the up and coming LEGO UNIVERSE. At the same time they have not lost sight of the LEGO experience, with the real LEGO bricks.

My time with the team at LEGO has been so great, but I am now moving back to Spain to start on another path.

I will miss everyone greatly, but I can go back to my LEGO Collection with fond memories of my adventure to Denmark. 

For an AFOL who has only been building for about seven years now, Yoshikazu Saito really has come a long way. He is known in Japan as the "Parts Specialist" and visiting his LEGO room in Tokyo one immediately understands why.

Floor to ceiling, wall to wall are lined with filing drawers Saito-san uses to sort the vast collection of LEGO parts that he has. Although he does have a few buckets filled with standard bricks and plates, the majority of his assortment are speciality pieces. From drawers filled with 100s of Minifig binoculars (part # 30162) to cases sorting various LEGO animals that he uses in very creative ways in his MOCs, he seems to have almost every part covered.

Besides building with LEGO bricks and parts, Saito-san has a wide variety of interests, including being a record DJ, backpacking around the world, and writing books about American TV shows. He works as a technical writer at a Tokyo publishing company.

In Japan and in the AFOL community, he is known as being one of the contestants on *TV Champion* but even known more famously for the two books on building with LEGO bricks that he wrote; *Let's Play with Block Toys!* (the 'green book') and *Let's Play with Block Toys, Continued!!* (the 'red book'). He is also one of the main pillars for the 'Brick Fan Town' exhibit at the Nasu Amusement Park outside of Tokyo.

Saito-san doesn't know why his parents never got him LEGO blocks as a child, but from an early age he has enjoyed building things. Up through his adult years he enjoyed spending time building various plastic models. After getting married and having children, though, he thought that having plastic glue and thinner, and the fumes that come with them, was not the best environment to have and he started looking for something else to relax with.

A friend introduced him to LEGO bricks which were "model building without glue" and he was hooked. One of the things that grabbed his imagination right from the first time he used them, was the feeling that models never were actually completed and could continue to be modified and refined.

His favorite genres for building are creating robot models and fighter jet airplanes. Over the years he has built an extensive range of various MOCs in many genres. Saito-san has created small LEGO Sushi and Japanese sweets MOCs as well as a large restaurant diorama.



Yoshikazu Saito: Parts Specialist

Article and Photography
by Nathan Bryan
www.brickzen.com

Saito-san's books,
sought after in Japan
and overseas.





Saito-san's Greater Panda.

The Lesser Panda that he created for the show *TV Champion* is an excellent example of his use of special parts in creative ways. Viking horns (part #4273397) become animal claws and Harry Potter Owls (part #x62) are used facing backwards to become the Panda's furry eyebrows! Since it was his first (and he says only) time he built a MOC of an animal, it was his most difficult project.

From his fascination with American TV shows he even created a set of minifig characters representing the cast of *Buffy the Vampire Slayer*.

In collecting so many specialty parts, he often gets his inspiration for a new MOC from a single piece. When he first saw a 1x1 slope (part # 50746) he immediately thought of building a Gundam Valkyrie. Seeing the barbed vine (part # 55236) from the Bionicle sets he thought of combining that with a mechanical arm (part #bb191) to create the baby alien creature from the original *Alien* film.

That then led to his building a MOC of Ripley and the cargo loader.

His favorite parts are the "T" bar (part # 4696b) and sink tap (part # 4599) which he uses extensively for creating joints when building robot MOCs.

His rows of drawers of parts are very well organized and as he builds, he know exactly where things are so that he can focus on the MOC and not spend time searching for a certain part.



The cast from Buffy the Vampire Slayer.

As he built up his collection, increased his building techniques and started meeting other AFOLs. Seeing their MOCs he thought it would be great to have a book, or more correctly, a textbook that would show various building styles, close-ups and pictures of MOCs broken into a few pieces so that one could see how they were made. With there being no such books available in Japan and the LEGO Group's 50th anniversary coming up, he submitted a plan to the publishing company that he works for and it was accepted. He accumulated so much information that the book actually became two books that were both published in 2008!



From two parts come an alien creature!



With only a few elements of inspiration, an entire model is created.

The books cover an extremely wide range of building styles from robots and airplanes, trains, vehicles, animals, town buildings and use of Power Functions in models (ie. a working garage door, an escalator for minifigs, etc.) Not only are completed models shown, but there are many close-up shots of interesting techniques and also there are pictures of models taken apart to show how they were constructed. He even has "Steal This Technique!" shots of building techniques that he thinks many people should try in their own models.

The books not only provide many MOCs and techniques for AFOLs to look at and study, but the inside of the covers of the books are 'LEGO Graph Paper' that he encourages people to photocopy and use for thinking up new MOCs (one book has side view paper and the other top view paper).

Through the *TV Champion* show and writing the two books he got a chance to meet many AFOLs in Japan and see many different techniques. At one gathering several people had brought MOCs of buildings. Although each was quite interesting by itself, when they lined all of the various buildings up together, the creation of a "town" just blew away everyone attending. They decided immediately to try to create even a bigger version. Nasu Amusement Park outside of Tokyo agreed to provide a space and the 'Brick Fan Town' was born. Originally it was to be a short event, but it generated so much interest from the general public, that Nasu Amusement Park



A robot creation.



 **RAILBRICKS**
BRICK RAILROADING MAGAZINE

Quarterly E-Magazine devoted to LEGO® Trains

Tips & Tricks • Building Instructions • Builder Profiles • And More!

<http://www.railbricks.com>

 **RAILBRICKS**



Sushi, almost good enough to eat!

agreed to host the exhibit for an extended run. New exhibits just opened up May of 2009.

With various new LEGO sets and new special parts coming out frequently, there will most certainly be many new ideas and inspirations for Saito-san. There are sure to be many more innovative models coming out of Yoshikazu Saito's LEGO Parts room. Be sure to check out what he pieces together! 🧱

Yoshikazu Saito's Blog (Japanese Only):
<http://lego.cocolog-nifty.com/>

Brick Fan Town Home Page (Japanese Only):
http://www.big.or.jp/~hilo/brick_fan_town/

Nasu Highland Home Page (Japanese Only):
<http://www.nasuhai.co.jp/event/lego.html>



Seaside restaurant.





When I sat down at a table stocked with bricks in the LEGOLAND California Build & Test building in June 2008, I could hardly imagine the chain of events that would unfold and ultimately lead me to a dream come true for many an AFOL: a tour of the LEGOLAND model shop and quality time with a master model builder.

When I'm not up against a deadline for a film (I'm a professional artist working in the motion picture industry), One of my favorite activities on my regular trips to LEGOLAND is competing at the monthly Junior Master Model Builder event. Park guests are invited to participate in three age categories and build with thousands of supplied LEGO elements along an announced theme. In June 2008, the theme was "summer fun," and I chose to build a Miniland scale couple enjoying a nice picnic. I spent a few fun-filled hours building my model and defending my small stockpile of found bricks from the speedy little paws of my fellow LEGO enthusiasts of the younger persuasion. Much to my surprise, I won the event in my age category and was invited back in December with all the monthly winners to compete in the build-off.

This time around there were more rules: we only had an hour to build, could not use any reference and could not have anyone help us. All we knew going in was the theme: "space." I went in with a few ideas and after scoping out the parts on hand I settled on what I imagined the next generation space telescope would look like. After an hour of frantic but fun building my creation was complete. Then

People

THE BRICK-PAVED ROAD TO THE

LEGOLAND MODEL SHOP

How I won just
about the coolest prize ever

Article and photographs
by Tommy Williamson
roguefx@yahoo.com



My winning entry from the June 2008 Junior Master Model Builder.

Matt Armstrong and me building frantically at the Build-Off.



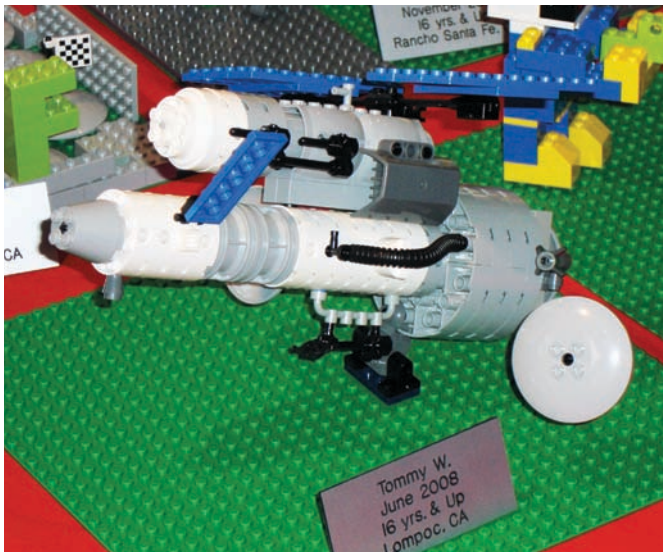

My winning entry in the Build-Off, the next generation space telescope.

I looked around and my heart sank a bit. I was only one of eleven competitors and was quickly humbled by many of their creations. As they reset the room to announce the winner I settled down with my family and cheering section. I really had no expectation of winning, but was excited and considered myself a winner when I spied the eleven trophies being carefully arranged on a table. We all lined up and anxiously awaited the winner's name, each silently evaluating the competition.

My jaw dropped as I heard my name called and shuffled dumbstruck to the middle of the room to shake hands with Gary and Bill, the judges of the event. In addition to my nifty trophy I was handed a huge bundle of prizes including several LEGO sets, some clothing, a book, memberships to LEGOLAND and several other items. As if that wasn't enough my prize also included a LEGO mosaic portrait of myself and a meet & greet with a LEGOLAND master model builder!

In April 2009 my family and I returned to LEGOLAND to redeem my remaining prizes. Master model builder Gary McIntire was our host and was kind enough to allow me to bring my wife and two boys along for the tour. We were to meet at 1:00 pm at the model shop adjacent to Miniland. Visitors to the park will recall that there is a large glass viewing area in the model shop where you can see the model builders hard at work. We went in to take a peek and there was Gary, feverishly putting the final touches on my mosaic. It was a little odd (but outrageously cool) to see a picture of me being



completed on one of those sacred workbenches. After a moment Gary glanced up and recognized me. He came out and warmly greeted me and my family, inviting us in to the hallowed space so admired by nerds like me. As far as tours go, there's truthfully not much to see in the LEGOLAND model shop. Besides four workbenches and dozens of LEGO models both big and small, there are mostly just



LEGOLAND Master Model Builder Gary McIntire.

rows and rows of shelves. Of course those shelves are lined with bins, and those bins are stocked with literally thousands of LEGO pieces. Gary explained how they are arranged by type and color, and showed us their special tool for retrieving high bins without using a ladder. It seemed at first that Gary was feeling a bit awkward, perhaps not totally at ease with this more ambassadorial aspect of his job. But that was short-lived as we all talked and joked about life in the model shop. Gary and I quickly hit it off. We had met before but had never really had a chance to speak at length. Despite our age difference, Gary and I are somewhat kindred spirits. Both fans of LEGO, Star Wars, and we share a quirky sense of humor. We even enjoyed a few minutes of what my wife called "the mutual admiration club" as Gary skimmed my list of film credits and I gawked at some of his models. Good times.

The next thing we did was participate in what is becoming a bit of a tradition on model shop tours, we built Miniland versions of ourselves. Gary quickly sized up our outfits and made some suggestions. With a deftness to be admired Gary would vanish over and over, just to return seconds later with exactly the right parts. We started with our heads.

My signature hat was sorted out pretty quick and I threw a curve at Gary requesting sunglasses. He responded in seconds with two tan “washing machines” (also known as headlamp bricks) and two 1 x 1 dark transparent tiles. A clever technique but it did make me look a bit permanently surprised. My wife’s hair posed a bit of a challenge that was taken care of with a very cool capture technique. Both my boy’s noggins were pretty simple to build and we moved on to our bodies. I got to work constructing a torso with 1 x 1 Technic bricks and flowers (hey, I was wearing a Hawaiian shirt alright?) while Gary helped my son figure out the challenge of his striped shirt. We built for about 20 minutes while parkgoers stared and pointed at us through the glass. When all the figures



Gary assists my wife and son with their Miniland scale figures

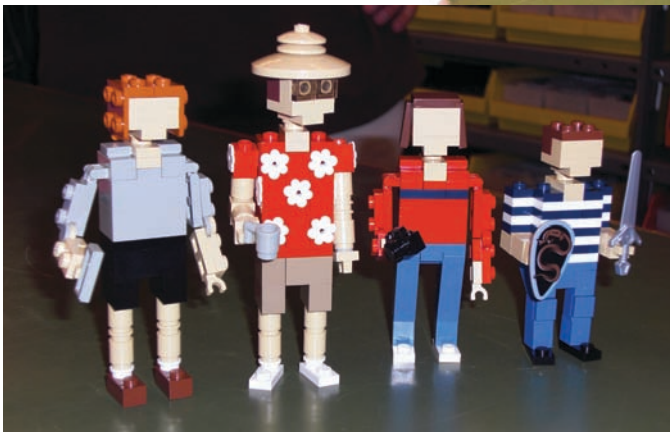

The Miniland Williamsons

seemed to be completed Gary did a little height comparison and with a quick modification to my son’s feet everyone was in proportion to each other (my wife thought that was so sweet).

Gary was awesome, never missing a beat as he helped us build and volleyed our continual and occasionally bizarre questions. It turns out the model builders do feel a little like animals in a zoo from time to time. In my opinion, they are far more interesting than any three toed sloth I ever saw in captivity.

With our miniature LEGO doppelgangers complete we were presented with a choice, we could install them in Miniland, we could temporarily place them in Miniland to shoot a few pictures, or we could just take them and scoot. I was all for making them a permanent addition (or as least as permanent as anything is in Miniland, it’s always evolving) but my youngest was having none of that. He wanted to take his figure home and there was no talking him out of it. So we agreed we would take them out and snap some pictures. We then proceeded to the animation department next door. Gary showed us how the cars in Miniland start and stop and find their way around the miniature roads



A small sample of the dozens of LEGO models on display



Gary with our miniland family.



Our Limo pulled up for a photo opportunity.

outside. We also got to see the brains of all the music and action all over the park. Banks and banks of special sound producing modules and micro controllers all hummed away, diligently filling their role in the day to day park magic. After that we headed out to Miniland.

Grauman's Chinese Theater seemed a natural choice as a photo backdrop to me, and my family happily obliged. So we headed over there and without hesitation Gary hopped the barrier and we handed him our figures. With a little push to encourage a limousine parked out front on its way he placed us one by one in front of the awning. We had time to snap a few shots before the limo came back. Luckily it didn't run any of us over and we snapped a few more pictures. There we were, all set for a gala Hollywood premiere (wearing shorts and a Hawaiian shirt no less). I've been to a few premieres in my two decades in the movie business and none were even close to making me feel this giddy. As curious onlookers started to gather Gary posed for a couple more pictures and retrieved our figures for us.

With a heartfelt thank you, I shook his hand and bid him farewell. My family said their goodbyes as well and we all departed. We spent the rest of the day in the park blissfully recalling all the details of the tour. I'm so happy I could share that time with my family, memories like that are few and far between. I can honestly say it was my favorite visit to LEGO-LAND, I hope to someday visit the model shop again. Our figures are all standing on the mantle now, a fantastic souvenir of our visit and time with Gary. Although I must confess, I modified my sunglasses. 



One of my personal favorite sculptures in the model shop.



Spring in California. It's that two-second window between the damp chill of a Southwestern winter and the sweltering heat of the area's seemingly endless summers. In other words, it's a blessed, brief respite between two extremes.

On such a spring day, I walk down a nondescript street in the San Fernando Valley, past the kids on their skateboards and the accompanying clatter of a hundred failed ollies (a skateboard trick). I continue on, avoiding an ice cream vendor incongruously playing a lullaby through his truck's tinny speakers. I can see through his grimy window that he is asleep, apparently the victim of his own ill chosen siren song. Finally, arriving at the terminal end of this cacophonous cul-de-sac, I make my way up the stairs to Brandon Griffith's apartment. I'm here to visit a man who makes art amid such chaos and who seeks order in seemingly disparate colors, shapes and sounds.

Brandon Griffith is a Renaissance man; a master of many forms of expression, constructing elaborate pieces of art from the basic elements of construction: bricks in his sculptural work and multi-colored rectangles of digital audio in his professional life as a sound designer. In this part of the world, if it aligns itself correctly, beautifully, or if it snaps together, chances are Brandon Griffith is the guy who made it all come together.

Brandon greets me at the door and we make our way into the dark of his modest Swedish Modern apartment. "Watch out for the mess," he warns me. Rucksacks, tents and other camping supplies litter the floor. He has just come back from a sound-collecting trip into the Sierra Nevadas. "I had to get some recordings of twilight vocalizations from coyotes in the region. A director I'm working with wanted a specific sound for a film and I knew this one pack I'd been tracking would be perfect."

I take a seat in an overstuffed armchair and, as my eyes adjust to the gloom, I examine all of the LEGO-constructed art that adorns the walls and is displayed on the shelves and cabinets around the room. Two huge, mind bogglingly intricate mosaics hang in the stairwell and an amazingly engineered Klingon *Bird of Prey* sits in mute, perpetual rivalry alongside a perfectly realized *Enterprise*.

This is impressive, meticulous work with an attention to detail that makes even the smallest element of design pop. The *Bird of Prey* is perched at the ready, menacing and perfectly detailed. Its base is cleverly designed to represent the Klingon Empire insignia. Surprises abound upon closer inspection of the work; no stray bricks or poor construction

Brandon on the Edge of Forever

Article by Richard Kaponas

*Photography by Ellen Wang
(www.lecrustudio.com)*



lay in wait to disturb the eye. Logic and mathematical reason reign supreme in Griffith's creative workshop, which isn't to say that his art is cold – far from it. Staying within a strict set of boundaries defined by the LEGO materials and the LEGO community, Brandon is able to create wonderfully vibrant, almost organic works within the harshest of constraints.

In the hands of lesser artists, labor is the defining characteristic of such complex work. Griffith, however, is not punching a clock. He makes it all look easy. All one sees is the beautiful plastic surface and not the headache inducing structural work, nor the process beneath.

"I was just about to eat. You want some ribs?" Brandon asks. He offers me a plate, sits down on his couch and starts in on a rack of barbequed meat that would make Fred Flintstone envious. I ask how he got started in the LEGO community. "Like most AFOLs, I began my journey into LEGO at the age of two and continued on until I was twelve. In my teenage years, I was a bit scattered between other interests such as women and playing in a rock band but later, when Star Wars LEGO came on the scene, I couldn't resist the urge to come back to the LEGO scene. Just when I thought I was out, LEGO pulled me back in."

"As I started collecting and building the *Star Wars* sets, the passion I had as a child for creating came back to me," Brandon says, wiping his mouth with a napkin. "I began to



develop ideas for a large-scale LEGO creation. After a lot of research on the Internet I soon realized that I had all the resources available to build whatever I wanted. Assuming, of course, I could afford it."

"I grew up watching *Star Trek* all the time," he reminisces. "I remember the 'Star Trek: The Original Series Chain Reactions' on Sci-Fi channel and how cool I thought the *Enterprise* was. *Star Trek 3: The Search for Spock* became one of my favorite *Star Trek* movies. It featured the Klingon Bird of Prey. When I was deciding on what ships to build, I knew for sure that I wanted to build the *Enterprise* but I felt like I lacked the skills to do it justice."

"My first con was BrickFest 2004. I was pretty new to the community, so needless to say, BrickFest was a real eye opener for me," he laughs. "Two models that really stood out to me were Jason Allemann's *Discovery 1* and the *Leonov*. The detail and scope of his work blew me away and motivated me to expand my own building horizons. It was then I made the decision to build some of my favorite iconic sci-fi ships. About six months after BrickFest 2004, I started on the *Klingon Bird of Prey*."

I ask about his research. "I began searching the Internet for reference pictures from movies, television shows and pictures of MOCs that came before me," he explains. "I knew I wanted to be as true to the original ships as possible in all aspects, especially scale and color. At the same time, I wanted to build a LEGO



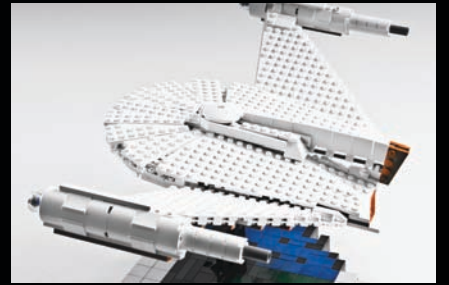
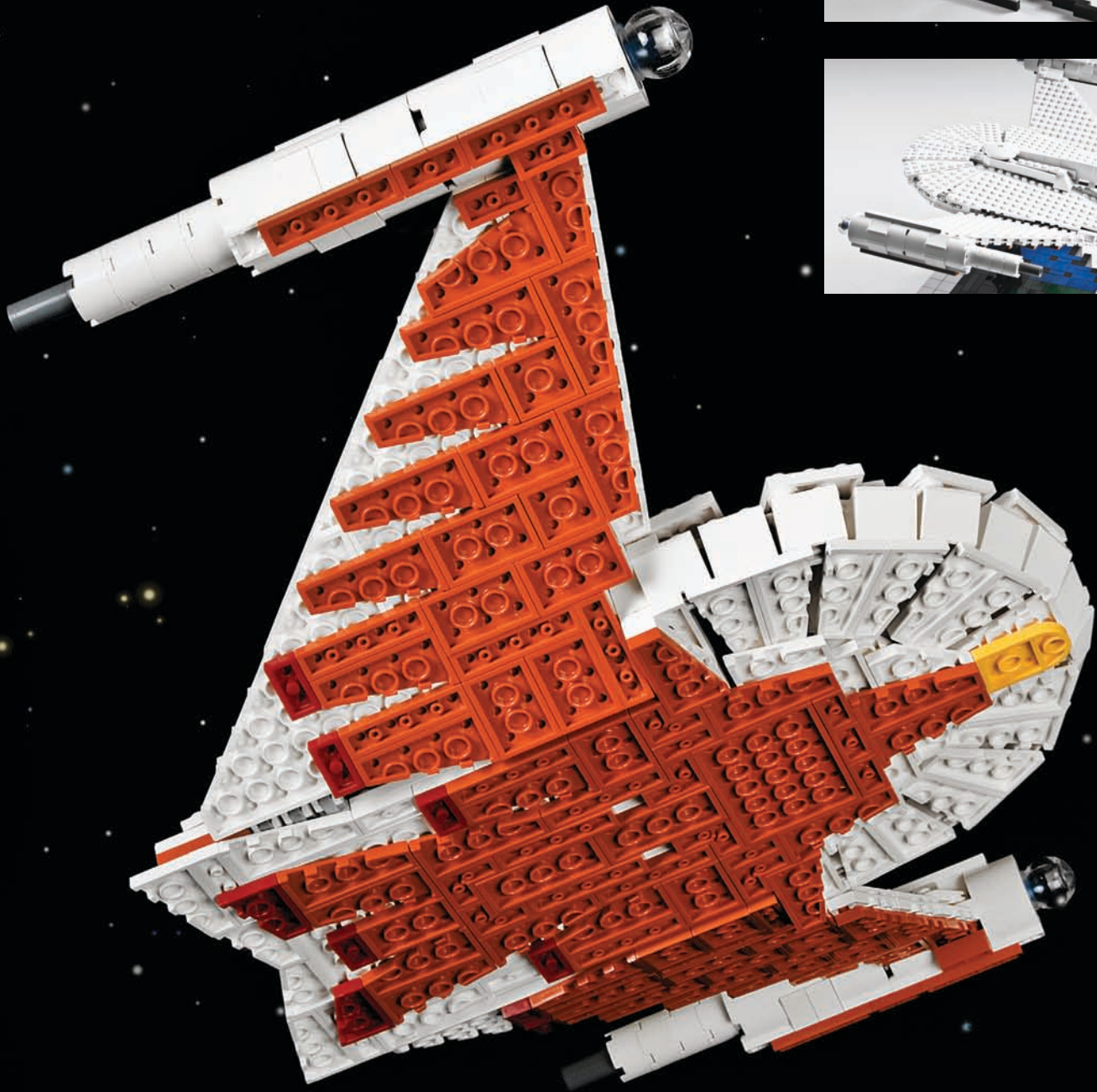



version in a way that had never been done before. I wanted to utilize as many new and unique elements as possible to really bring out the different shapes that appear on the ship.”

We get up and walk over to the Klingon *Bird of Prey*. Brandon wipes the barbeque sauce from his fingers and picks up the piece, obviously humbled by his accomplishment. He turns it over in his hands and continues, “Building on the Klingon B.O.P. began in late 2004. Because of the massive learning curve I was attempting to overcome I went through several versions of each section of the ship. For example, the wings were originally fixed in my early design. I decided they needed to be movable as they are in the film. The head of ship was originally studs up but I ended up using a SNOT technique to round it out.”

“I finished the project in April of 2005. Before I finished it, I started work on the *Enterprise* and did not get far,” Brandon chuckles. “Right from the beginning I was running into several design problems and my free time and problem solving powers were taken up with graduating college and moving across country. During this move I decided to leave the LEGO behind in storage with my parents and hoped that one day I could pick it back up. Soon after moving to L.A., I got connected with Bryce McGlone. At the time I was still fairly green when it came to ‘popular’ builders and what they had done. I had seen some of his work online, but never connected it with a name. He would have a small group of three or four people over about twice a month and just sit around his garage with his stockpile of LEGO and just build. Among this group’s members were the likes of Jeff Ranjo who had done some amazing work with integrating Bionicle and System and Dan Jassim whose ships I had seen online many times. Dan has a great sense of scale and proportion to his ships. This is where I learned the most about new building techniques. Getting to see these MOCs hands-on, I realized this hobby was not over for me. About eight months after I moved to L.A., I had my LEGOs shipped out from back home.”

At this point in the story, Brandon, now armed with a more sophisticated repertoire of LEGO engineering technique, resumed his work on the *Enterprise* in earnest. “I began with a reference schematic that came in *Star Trek Communicator* Issue 151,” he says from the kitchen, grabbing more ribs. “Using a ruler and a calculator, I figured out the scale of which to build the ship. The scale is based off of the diameter of one of the nacelles and matched it to a 2 stud x 4 stud x 4 stud half cylinder brick. The rest followed suit.”

We leave the *Bird of Prey* behind and move over to the *Enterprise*, sitting regally next to a rare leather-bound collection of antique nautical charts. Brandon picks up the model, continuing, “The first big task was the saucer section. I wanted it to be completely different from any other design ever made. The 12x3 wedge plate had just come out in a new Snowspeeder (set #4500). I gathered together enough to fan out a semi circle and mixed this with a technique I learned from Bryce utilizing Technic straws. This gave me a solid structure for the saucer section.”

“The hull and interconnecting dorsal was another huge challenge. Because of the scale, the dorsal, which connects the hull to the saucer section, could only be two studs thick. After many different designs, I finally came up with a structure that interconnected the hull and saucer section using Technic liftarms. Tiles attached to the liftarms with half pins provided the detail.”



"As I finished the *Enterprise*, I soon realized there was no way this thing was going to stand on its own. I designed a crude base for it, but it didn't look good and I felt it took away from the piece. Using the emblems of the fleet that each ship represented, I built a mosaic style 'cover' to mask the functionality of the base."

"The nacelles and the support pylons are held together by simple System connections. The real trick here is the connection of this assembly to the hull. But I will keep that little secret ensemble of Technic axles, lift arms and bricks to myself," he laughs as he places the *Enterprise* next to the pile of books and leads me past some vintage recording equipment and over to another corner of the room.



Brandon Griffith.

"As a sound editor, being familiar with the sound design 'rule of threes', I felt the two ships needed one more to round out the collection," Brandon says, gesturing with a half-eaten rib to another wonderfully constructed LEGO ship. "Finishing up the *Enterprise*, I racked my brain and settled on the Star Trek original series Romulan Warbird. When figuring out the scale, I realized I did not check the scale between the Klingon B.O.P. and the *Enterprise*. As fate would have it, the scale of the *Enterprise* was 1:578 and the scale of the Klingon Ship was 1:577. I couldn't believe it. With that in mind I began work on the Romulan Warbird."

"This model was built fairly quickly. The scale was almost perfect in deciding what parts to use. The most challenging aspect of this build was the emblem of a bird that is painted on the bottom of the ship. As iconic of a ship as this is in the *Star Trek* universe, there aren't a lot of reference pictures available. Most pictures were from the show so it was hard to tell what the exact color was on the original prop. I decided the Bird should be Earth orange. I investigated what was available in Earth orange and built the bird onto the bottom of the ship with that in mind."

We return to our seats. The afternoon sun has started to set. I ask him when the public first got a chance to see his creations. "The debut of all three ships was at BrickFest 2006. Two years after seeing Jason's *Discovery 1*, I had accomplished my goal of building not one but three iconic science fiction ships that match original design in scale and color. The Klingon Bird of Prey went on to win 'Best Medium Scale Space Ship' that year."

"Building these ships was a great learning experience for me," Griffith says, wiping his hands and standing. "It pushed my creative abilities and motivated me to reach for more lofty goals not only in LEGO, but in my career and my life as well. These models were a launching pad for bigger and more complex MOCs. I am now trying to push myself even further artistically with sculpture, mosaics, and even NXT."

"Being creative is part of who I am," Brandon says, collecting our plates and leading me toward the door. "Throughout my life I have tried many different artistic outlets to express that creativity. LEGO has proven to be one of the most compelling ways in which I can truly express myself. Within its complex system, many may feel bound and restricted. I see the building restrictions as a challenge that must be overcome. Not by 'other than LEGO' approaches, but by utilizing every option of color, part, and quantity available to me. These models represent my first attempt at overcoming these challenges."

As I walk away from Brandon's apartment and back into the dusky Californian haze, I think that, had things gone in another direction, he might build his sculptures out of stone or steel. He might craft his mosaics out of ceramic tile. But instead, he chose LEGO.

They say every artist must love their medium or their material. Brandon definitely connects with the bricks he connects. With each satisfying click of every brick, he's building bridges between his love of science fiction and problem solving. He's balancing creative expression and the absolute mathematic precision required by this modular building material. **b**



Creating the New Space Police

BrickJournal had an opportunity to talk to the design team behind the new Space Police line from LEGO: Tim Ainley (Designer), Adam Grabowski (Designer), Mark Stafford (Designer), Kjeld Walther Sørensen (Designer - Graphic Lab) and William Thorogood (Design Manager) Here's what they had to say about the line and how they designed it:

First tell us a little bit about yourselves, who are you, where are you from, what is your job, and how long have you been with LEGO?

WILL THOROGOOD - My name is Will. I'm 26 years old and I am a Design Manager in Playthemes. I'm from Stratford-upon-Avon in the UK and moved to Denmark 4 years ago to work here at LEGO.

TIM AINLEY: My name is Tim and I'm from Manchester, England. I've been at LEGO for 3 years working in the Playthemes design team. I worked on EXO-Force, Mars Mission, Power Miners, Space Police. Before LEGO I studied design for around 7 years and then started working for LEGO straight out of University. Outside LEGO you will find me mostly running around in a cape and falling over.

MARK STAFFORD: I'm Mark Stafford ('Nabii' to the fan world), I'm from Hull in Yorkshire, England and I've been

*Article by Hadley Scrowston
Photography by Mark Stafford*

Above: A very early piece of concept art by Freelance Concept Artist Brian Ellis (former set designer for LEGO Star Wars and Bionicle), this is also the very first image of 'Kranxx'. Brian is available for commissioned work and can be contacted at Bellisx@hotmail.com

A high concept sketch model of a Space Police interceptor by Soren D. Much of this design was incorporated into the separating engine pods of the Galactic Enforcer.

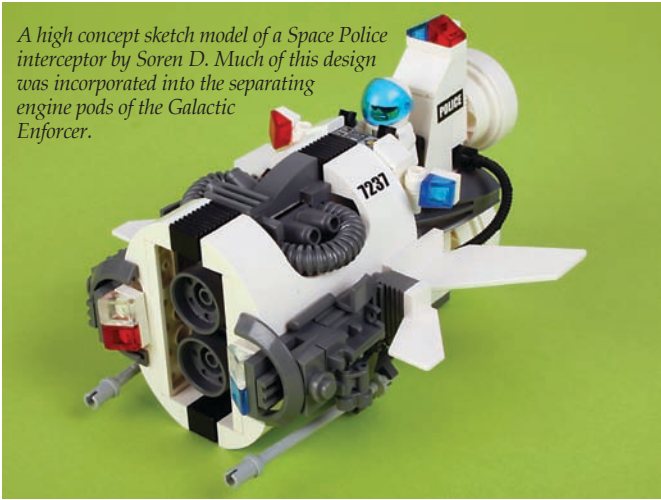

An early sketch of a possible space police bike.



Adam Grabowski's first sketch model of the space truck that Will Thorogood developed into the Container Heist set.

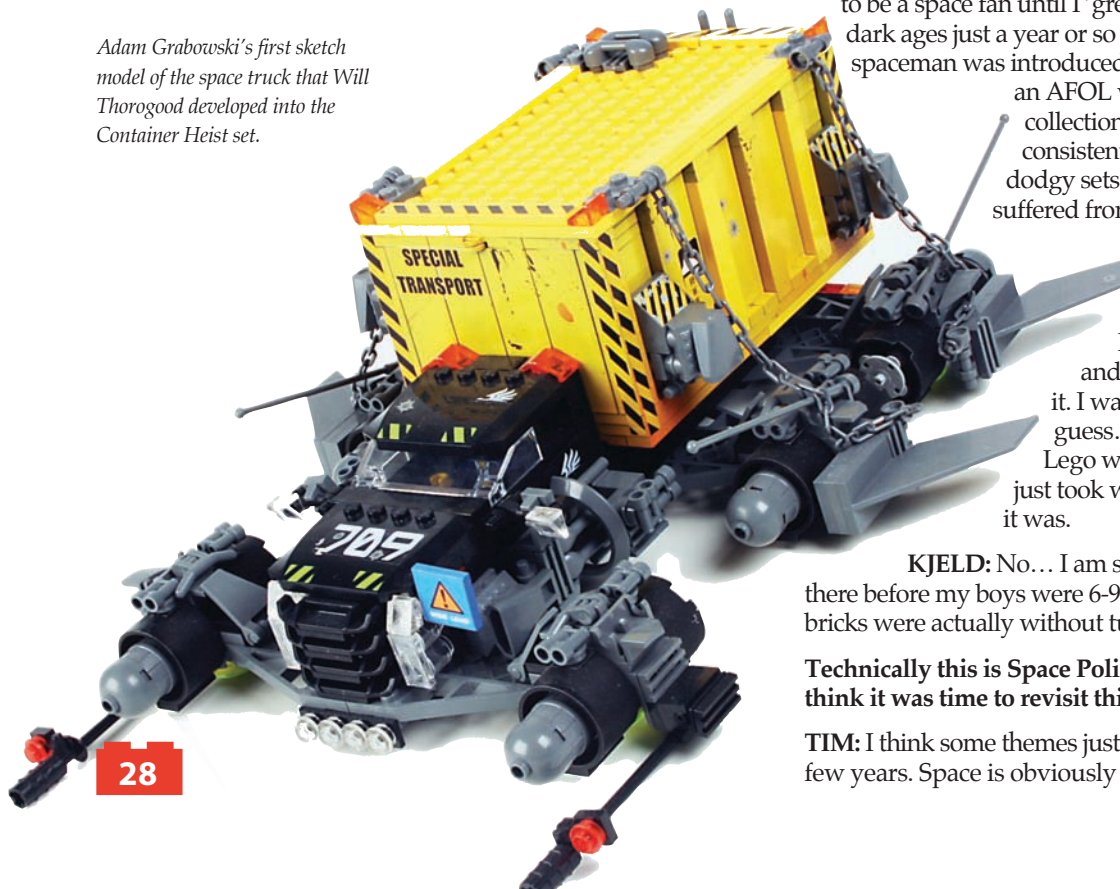

a LEGO Designer since October 2006. I've worked in Exo-Force, Agents, Mars Mission, Power Miners and Space Police.

ADAM GRABOWSKI: I have been using LEGO as a fan for a bit over six, maybe seven years now. Can't remember. I know that I've worked as a designer for the past two and a half years.

I was born in Poland, My mom is Polish, my dad was German, but my family wouldn't move to Germany before I was 15 or so.

KJELD WALTHER SØRENSEN: I am from Denmark but I am born in Sweden. I started as product designer (building models and making new elements), but over time I started to make more and more graphics for the themes. So for the last 9 years my job has been to make labels and decorations for the models and minifigs... most of the times for futuristic themes.

I have been at LEGO for 19 years.

Did you have space LEGO when you were a kid? If so can you remember which theme?

WILL: I absolutely loved space LEGO when I was a kid... and was lucky enough to have quite a bit! Space Police was a firm favorite of mine so getting to make a new version was really exciting for me! The bad guys that the space police arrested were always Blacktron2 (although at the time I didn't know there was a Blacktron 1) and there were also a few M-Tron sets in the mix!

TIM: I have quite a terrible memory, but I do remember owning a few small classic space sets, a Blacktron ship and some Forest men figures. I wanted to be an astronaut when I was younger, so guess I'm not far off. Maybe I can help inspire the astronauts of the future instead!

MARK: That's odd, I wanted to be an astronaut when I was a kid too! For me it was Classic Space all the way. My first space set was when it was first launched in 1979 and I continued to be a space fan until I 'grew out' of LEGO and into my dark ages just a year or so after the black suited classic spaceman was introduced. One of the first things I did as an AFOL was complete my M-Tron theme collection, by far my favorite space theme, consistently high quality with none of the dodgy sets that some other space themes suffered from.

ADAM: I had some Space stuff when I was a Kid. My first set was a space set, then I would have a tiny M-Tron set and a Space Police 1 ship. That's it. I was more into Pirates and city I guess... But growing up in Poland Lego was somehow hard to get, so you just took what you could, regardless what it was.

KJELD: No... I am so old that space LEGO wasn't there before my boys were 6-9 years old... my first LEGO bricks were actually without tubes :-)!

Technically this is Space Police 3. Why does each of you think it was time to revisit this theme again?

TIM: I think some themes just work and can be rotated every few years. Space is obviously a great theme, as kids love the

idea of exploring the galaxy and unknown worlds. A Police theme is something that is communicated easily and kids love the “cops and robbers” play experience. So combine the two and kids love it.

KJELD: It was maybe just the right timing I think.

ADAM: Was it really the time to revisit it? Do we need another Space Police? Really? Awww well... What do I know. Ask Mark...

MARK: It’s just so simple to explain (except to Adam). Show a kid a ship with ‘police’ on the side and a criminal looking ship and they get it immediately, “cops and robbers” most even say “space police” too, it’s a concept that is classic yet can be made very fresh with just a little bit of tweaking, I’m pretty sure one day we’ll do Space Police 4.

WILL: Space Police is such an easy to understand and iconic theme that it was, in my opinion, long overdue a remake! I liked it so much as a kid because you could play police stories like catching robbers but in space ships.... Obviously much cooler than a police car!!!

Why choose to make different aliens rather than a unified group of bad guys like in the past?

WILL: The idea was to give the kids loads of different characters to choose from and have a motley crew of renegades that are causing chaos across the galaxy in their own unique way! By looking different they automatically get their own personality that makes them more appealing than a swarm of clones..... (Mars Mission!!)

ADAM: Because Timbo needed a reason to launch Squidman I guess. I like the Aliens. They just came along and never left. Funny how some things work out.

KJELD: Its funnier with different characters and over time there has being more and more focus on the individual character, because of storylines, fan-magazines, web and much more.

TIM: We know that, for a lot of the kids, the main focus is the minifig. If kids have a minifig they can create stories quite easily. So for this theme we decided to have a lineup of the worst and craziest guys of the galaxy. Characters are very important for Playthemes sets but normally we only change decorations on faces etc. This time we switched the focus towards completely different baddies by molding new helmets/heads.

MARK: Yeah, these are the Galaxies rogues and wise-guys, I’m sure there are also good members of their species out there, but these are the renegades, all from different planets, all a bit nuts. Heck, one of them thinks he’s some kind of super-villain with a cape! They just see the settlements of Humans as easy pickings, they are not organized into an efficient criminal organization like Blacktron or Spyrius with their own ships and bases, but I’m sure they’d like to be!

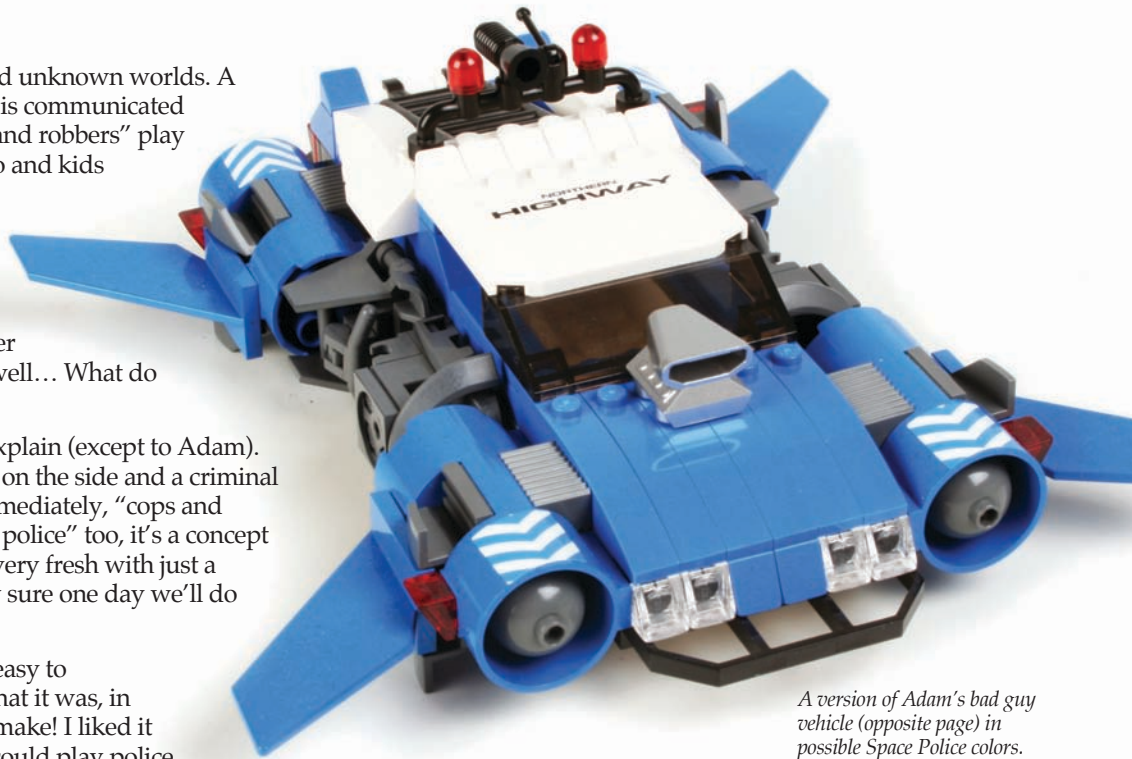

A version of Adam’s bad guy vehicle (opposite page) in possible Space Police colors.

“We decided that putting rocket engines on vehicles from the “real world” would be a cool style. When we tested this with kids they loved it, probably because it was basically flying vehicles with lasers from the world they know.”

—Tim Ainley

A mid-development version of the High Security Transport developed by Harry B. who was not available for this interview.





A 'classic space' ship designed by Mark Stafford.



The original Squidman shows a little gun to his replacement!

The final sketch model by Adam Grabowski of the Hyperspeed pursuit bad guy spaceship. Mark Stafford was responsible for developing it into the final version.



Which models were you set designer on, and are they yours from scratch or are they based on sketch models by another designer?

KJELD: As mentioned before, I made the graphics for all the minifigs and models for the whole theme. Most of the time I concentrate about that part of the process, but I can of course always make comments or suggestions about a models if I have any ideas.

TIM: I designed Squidman Escape and also Squidman's Pitstop. Not too sure who this Squidman character is though!!! But I also designed all the new minifigure characters and did some sculpting work on some of them. So this took up a lot of time, whilst others were building models.

MARK: I designed the little K9-bot impulse set, the Galactic Enforcer and the Hyperspeed Pursuit set. All are by me from sketch onwards except for the bad guy 'hot-rod' in the Hyperspeed Pursuit which is based on a sketch model by Adam Grabowski (Brickshelf account: Mister Zumbi). He had been trying to perfect a LEGO version of Mad-Max's Interceptor from *The Road Warrior* as a fan model and I think some of that might have crept into his sketch model. I tried to be as faithful as possible to his original. I also like the police version he built, it gives me a Hill Street Blues meets Space Precinct vibe.

WILL: As Design Manager, I don't often get to work on individual SKU's (sets) but I was determined to on Space Police because it's just too cool not to! I ended up working on the Container Heist box, with the bad guys truck and loved making it as evil as possible with the big spikes and 'battle damage'. It was, however, not my model from the start; the honor goes to Adam 'MrZumbi' Grabowski.

ADAM: Well I left the team after the initial sketch phase to make some more *STAR WARS*. I am responsible for the flying bad guy car which is partly inspired by some vehicles in the Mad Max movie (Yeah! :D) and the Truck with the container and to some extent the bikes. I can't remember how many sketch models I did for the Space Police theme, I am sure that the car was the first, and the rest somehow evolved around already set "rules" that I made for myself. You know, some Space Bikers



Mark Stafford's high detail ship design.

dudes driving junky looking vehicles, that kind of things. Somehow the style was appealing enough so whoever it was, decided that it should be the way to go with the bad guys and there you have 'em. Funny enough the final models are not that far off the Things I made. Colors are a bit adjusted, the Truck was black and lime with a Yellow box, and the Falcon must have been almost entirely black. And they were missing the spikes and whatnot. Apparently Mark thought it would be fun to put them on (boooo!), but why ever it didn't change much more. I am very happy how the things came out in the end. Especially the Falcon set is very cool. I mean you get a Zumbi and a Nabii in one box. Except Pete Reid who will be disappointed by the lack of yellow windscreens everybody else should get on the floor and thank God for the set :D...

MARK: yeah, nice modesty Adam.

ADAM: I made some more stuff that didn't make it, maybe we can show the bad guys' garbage truck that I built; it's quite unique and certainly very cool flying thing utilizing useless elements and just kicks butt.

WILL – Nope. Keeping that under wraps for now!

There have been a few comments from AFOLs already about some exposed cockpits and helmets in this theme, why not fully enclose them?

TIM: In terms of helmets, the bad guys are not human so they don't need oxygen! Plus didn't the classic space minifig have trouble breathing, before we invented the visor?

WILL: We always prefer to fully enclose cockpits but sometimes it is not possible for the target users building ability. There are a lot of things that a 6 and 7 year old boy cannot build that and 8 or 9 year old can.

MARK: The Space Police are wearing breathing gear, the air is kept near their face by low powered magnetic shields, and some of the vehicles and aliens are also equipped with the same technology. The visor is only for use in dangerous places and helps to deflect lasers and phasers. (Go on, prove I'm wrong!)

ADAM: Come on, it's Space Police. It is Police in Space fighting Aliens that steal money and gold, both most likely absolutely useless in the future as we find materials that are

more interesting to have. For today's standards this whole thing is as impossible as Giant Robots walking the earth. It has to trigger children's imagination, and they frankly don't mind if the toy they are playing with lacks total physical and logical explanation.

Besides prove that it will be impossible to build a space vehicle like that in 100-1000 years from now and then you can comment your lungs out!

How do you come up with the look of the models, for example futuristic flying vehicles for the bad guys instead of more traditional spaceships, and how do you know your models are in the right direction?

WILL: Inspiration for model styling is not hard to find for space vehicles! There is so much popular culture focused around science fiction, be that films, books, websites, TV shows, that the biggest problem is often which inspiration to follow. Usually to find out if we are making things that kids like we just ask them. We always try and get kids in to look at and play with our models before putting them in a box just to make sure that they really enjoy them and that they can play how they want to without breaking the model.

KJELD: It's ideas that come up during the concept face: How the models is ending up is pretty much a mix of brainstorm, stomach feeling, research, kid tests and a lot of other stuff.

ADAM: Well I love vintage cars of the '70s and '80s and movies of the time like Mad Max. Always wanted to build

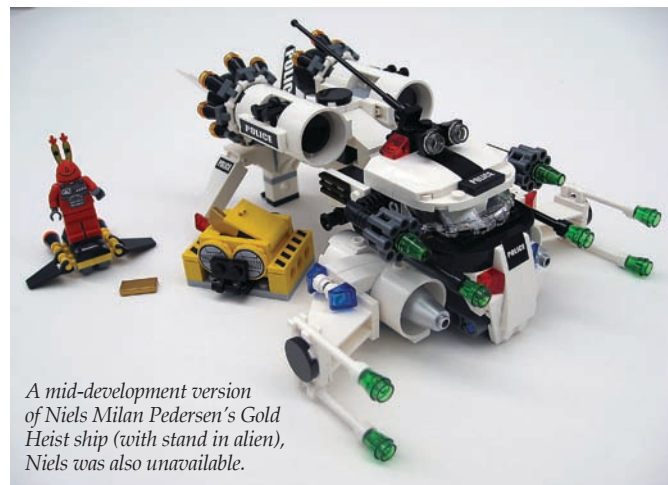

A mid-development version of Niels Milan Pedersen's Gold Heist ship (with stand in alien), Niels was also unavailable.

those cars, why not putting the wings on them? Give it a slightly apocalyptic/rusty/junk touch: ready. It was just a fun thing to do. I can remember that initially I made a drawing of a bad guy on a motorcycle lacking wheels and with a giant jet engine underneath chased by the flying car. Just for fun at first, but then made up a whole story around it, and managed to get people to do the same... Besides we never did it before, and no other company did stuff like that, so why not be the first? I like the look, I mean as the Police



Soren D.'s police cruiser sketch model that Niels Pedersen later developed into the final Gold Heist set.

“Pliskin was our original name choice for the orange alien but there was a legal issue, I suggested we call him ‘McReedy’ after another Kurt Russell sci-fi character, but in the end ‘Kranxx’ proved to not be anything rude in any language or copyrighted with someone else. Naming the characters is always a challenge.”

—Mark Stafford

vehicles are very traditional, the bad guys are brand new and still iconic. Children see it and they don't have a problem to understand what it is you give them to play there.

TIM: This can start in many different ways. It might be a brainstorm, a passing comment, a movie we watch or image we like the style of. But I think when we thought about the ships the bad guys of the galaxy might fly we had to look for something fresh and also something relevant to kids today. We decided that putting rocket engines on vehicles from the “real world” would be a cool style. When we tested this with kids they loved it, probably because it was basically flying vehicles with lasers from the world they know.

MARK: Yeah, as Tim and Adam say the kids we tested with loved the bad guys in modified ‘normal’ vehicles idea right from the start, instant understanding of what the vehicles do is always nice.

The direction of the Police vehicles was tougher; we tested several directions, from very classic space style right through to high concept. None of them came in as clear winners or losers, but details from each were picked out by the kids. The decision to go for the massive detailed engines, sleek pursuit vehicles and heavily armed aspects of the final ships came directly from this feedback. I know some fans believe we LEGO designers are ‘slaves to the focus groups and marketing’ but the kid tests we carry out can be very useful to help us as designers prove to more skeptical colleagues that we are developing in the right direction. For example, I might have been asked to put more into the front of the ships and tone down the engines because they are hard to see on the box front, but I had the kids’ opinions to call on and



A zero-stud (no stud showing) fighter designed by Mark Stafford. Aspects of the classic, high-detail and this model ended up in the Space Police ship in the Hyperspeed Pursuit set.

proof of how important powerful engines were to them. With the kids help we managed to polish this line into the cool perfection you see now! (I'm taking modesty lessons from Adam.)

Do you think the LEGO sets you had as a kid has influenced the sets you have designed? How?

TIM: I don't think so. Like I said, I didn't have that much LEGO when I was younger mainly because my family was not the richest of families. So with LEGO being quite a premium product, I didn't have that many sets. I can see now why some families are tempted by the cheaper "copies" but they obviously sacrifice quality for price. You can tell that some designers are influenced by sets they once owned. Mainly by any cool functions they remember because obviously styles change with time.

WILL: I think they probably did – I was a huge technic fan when I was younger and since then have loved functions that surprised me or worked really well. I always like to get things like that in any product line that I develop just because I remember how cool it was when I was to play with them when I was 8!

ADAM: Puh. No Idea. Really. If yes I should be designing Pirate ships I guess.

MARK: Yes, directly. I know how much fun it is to have a space buggy in the back because it was in the Galaxy Explorer (my cousin had it, I still don't have one!) And I know how much fun splitting the ship into smaller ships is because I remember playing with my Galaxy Commander in 1983! I just hope with the Galactic Enforcer I've designed a large LEGO ship that can be mentioned favorably alongside these classics.

I also suggested the statue to the classic space line as one of the 'treasures' the bad guys could be stealing just because I loved the first LEGO space line.

KJELD: On these space sets I think there is some influence from earlier themes from time to time, such as using the old space logo on the statue figure.

How about fan creations, do they ever influenced your models?

TIM: I wouldn't say so really. I do like to see what the fans are building as it can be quite eye-opening to see the amazing models and the crazy building techniques. But I like to get

my inspiration from as broad a spectrum as possible so I usually look at concept art or in my brain for ideas.

MARK: Maybe, but only subconsciously. The only exception I can think of is the Chris Giddens inspired 'SLAM' fighter-ship I built to test with the kids. That was based on a SLAM Chris built at LEGO a few years back when the Mars Mission theme was being developed (his original now sits proudly on my desk with a shiny new Star Justice mini-figure in it).

ADAM: Not mine or anyone else's. At last I can say that. Honestly. I mean before I was asked to do the Space Police stuff I can't remember ever building something that was flying in space. Oh yeah, I built Sandy's Rocket, and obviously the Star Wars things, or was Space Police before that? I don't remember. But other than that, never...

KJELD: No, not that much... but it's also not often you guys make graphics for your models:-)

WILL: Fan models are mostly inspirational to us because they really show the passion that so many people have for the brand that our products represent. Seeing them makes you remember that everything with a LEGO logo on it needs to be special and give the kid (or adult) an experience they will always treasure.

Squidman? He doesn't look much like a squid does he, and some people have noticed the preliminary name of Pliskin for the alien finally called Kranxx—what's the deal with naming the aliens?

WILL: Pliskin was a preliminary name that we used because we liked it – unfortunately when we finalise these things we have to get legal approval so obviously Pliskin was not available for us to use!

ADAM: Dunno. Squidman is Tim's creation, he made him up at his job interview here at Lego I believe. But no idea how it came this far... Ask Tim. The other two names I heard for the first time today :D...

MARK: Squidman is Tim's baby. I reckon Tim might be Squidman... there are some very strange video's on YouTube... but maybe I'm just being paranoid.

Pliskin was our original name choice for the orange alien but there was a legal issue, I suggested we call him 'McReedy' after another Kurt Russell sci-fi character, but in the end 'Kranxx' proved to not be anything

rude in any language or copyrighted with someone else. Naming the characters is always a challenge.

TIM: Squidman is basically half-man, half-squid. Squidman originated from my interview for the job here at LEGO. I originally used that strange technic piece on the minifig and a cape to create the character. The big eyes were the main inspiration for the name. The name Pliskin came from "Escape from New York", but we were not allowed to call him this for legal reasons. When it comes to naming the Aliens, we all brainstorm the coolest names we can think of. This can be quite a frustrating process as a lot of the time our cool names are rejected for legal reasons. We also have to make them short, easy to remember, descriptive and multilingual.

KJELD: It would be a little bit boring without names or just number 1-2 and so on.

It's a part of give them more personality because they (the figs) mean a lot to the kids.

What would you like to see the LEGO Group do in relation to the Space theme in future?

TIM: Squidman's own playtheme would be nice of course. But this would leave kids all over the world with no money.

Resulting in a huge economic disaster and sending the world into mayhem. This would play right into Dr. Squid's hands and his master plan to overthrow LEGO and the World would be a doddle.

MARK: Yeah, it's no coincidence the current economic spiral started just as these two sets were finalized. We're swimming in dangerous waters with Squidman.

Wait. "Dr. Squid"? Who? Tim?

TIM: ...

MARK: Okay, whatever. I like the visual style and concept of *Starship Troopers*, *Aliens* and the Halo games and I'd really love to create this kind of 'future war' theme, but I think it would be pushing the conflict level way past LEGO values! I'll content myself with know that my Exo-Force, the Mars Mission Walker and the Space Police ships when built in Grey and placed together look like a bad-ass military force!

ADAM: Space [censored as this idea is too good and might happen] Yeah that would be it. Trying to persuade the People to do that but haven't been very successful by now.

WILL: Space has so many opportunities for so many exciting new themes that I really just want to make a whole load more! Watch this space..... (no pun intended!) 

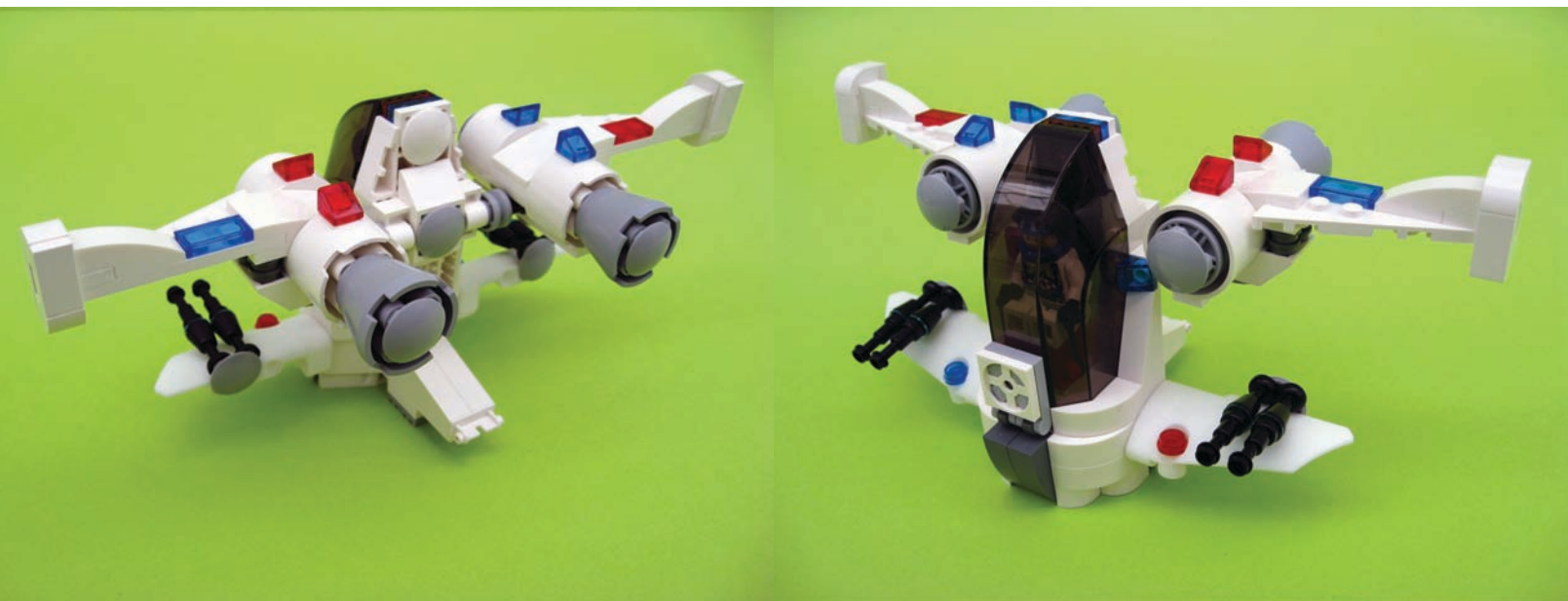

Mark Stafford's SLAM derivative fighter based on a sketch by Chris Giddens.



Advertise In **Brick** Journal

people • building • community

FULL-COLOR Ad Rates:

Color Back Cover (8.375" x 10.875", full color): \$1200

Inside Front Cover (7.5" x 10", full-color): \$1000

Inside Back Cover (7.5" x 10", full-color): \$1000

Full Page interior (7.5" x 10", full-color): \$800

Half Page interior (7.5" x 4.875", full-color): \$500

Quarter Page interior (3.625" x 4.875", full-color): \$300

These rates are for ads supplied digitally (PDF, JPEG, TIF, EPS, or Quark/InDesign files accepted). No agency discounts apply.

We accept check, money order, and all major credit cards; include card number and expiration date.

Send ad copy and payment (US funds) to: TwoMorrows Publishing • 10407 Bedfordtown Dr. • Raleigh, NC 27614
919-449-0344 • fax 919-449-0327 • E-mail: twomorrows@aol.com

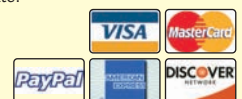



BrickJournal was able to talk to one of the alien designers for the Space Police theme, Tim Ainley. Here's what he had to say about designing the figures in the line!

BrickJournal: Why is there more of a focus on characters with Space Police?

Tim Ainley: When we start to generate concepts for any Playtheme we are always designing characters along with models. Early in the process, we had some good ideas for different characters and we know it's the main focus for a lot of kids. So we decided to test a lot of different characters with kids and they really liked the idea of capturing all the bad-ass guys of the Galaxy. Also from a marketing point of view it was a good way the product line could be differentiated from other lines.

Where do you start when designing characters?

We started by brainstorming in groups. I was able to consolidate some of the best aspects from these brainstorms and then start to draw up some initial concepts. The illustration on the next page shows the eleven concepts we took to the test. We of course had many more ideas from the initial concept phase, but we had to narrow them down into a manageable size for testing. Consolidating all the best features

Character Building: Creating the Aliens for Space Police

Article by Hadley Scrowston

Graphics provided by the LEGO Group





Initial concept sketches.

into a range kids can easily choose from. When I was creating these characters I was getting inspiration from a variety sources along the way. Different places such as movies, books, websites, strangers on the street, characters in my head etc.

Can you explain why each character was chosen?

The characters that made it through the final testing phase were in there for many different reasons. Generally I tried to make them all as different as possible so we could pin point the aspects the kids liked. Some were simply cool helmets and I created the characters by working from the helmets down.

From top left; A simple alien that would require no new elements. A stereotypical looking alien guy with four arms. "Kranxx" basically because we all liked him.

An evil looking race driver because kids like racing. Squidman because he's crazy and wears a cape. Some kids saw Squidman as the leader because the cape gave him superiority. Spike because kids love spikes. Due to toy safety standards we can't make parts too sharp or spiky. So we have to round off spikes to make them safe for kids to play with. The two headed guy because we thought it would be something different to the usual one head, but it turned out kids didn't really understand which side he was on. Straitjacket guy was the evilest of all bad guys. But even though most of us really liked him, the kids didn't find him appealing. The guy with the mask and one arm became "Snake" because we were not able to create a

Snake's helmet prototype.



mould that could just be a mask and also support a visor. The android character was in there to give the option of a non-living character. The biker guy is less fantasy and closer to real life.

How do you take the designs from paper to physical model?

Because of the complexity we usually sculpt the heads/helmets in 3:1 scale. This makes them easier to work with when detailing and reworking. Sometimes we create more drawings to work from and when we start sculpting we have to think about how the part is going to be molded. Then the sculpts are scanned in a magical machine which creates a 3D virtual model. This 3D model can then be manipulated by part designers for them to produce prototypes and the final production mould. It sounds quite simple but this process can take months to achieve the right results.

The rest of the characters are decorations on the head and body which are carried out by a graphic designer. Again sometimes original designs have to be altered as there are limits to the amount of colors you can use and the line thicknesses in the decoration process.

Will any of the characters appear in other LEGO lines?

Probably not. You never know, Squidman may pop up somewhere again, but generally we like to create new characters. It means something new for the kids and means we get to come up with crazy new characters too. But I don't think the kids would mind. They would just find it funny if Squidman turned up in a City police car. 

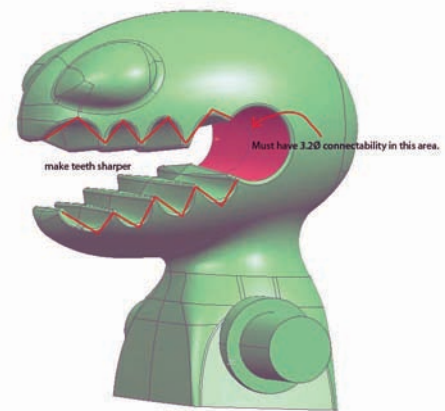
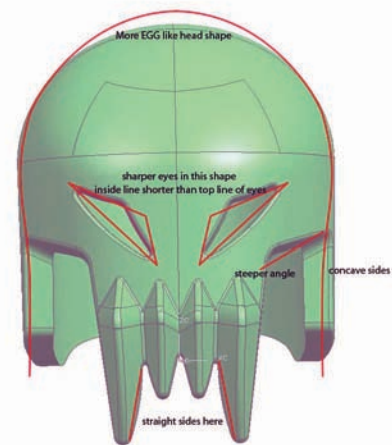

Frenzy 3D prototype with comments.



Squidman 3D prototypes.

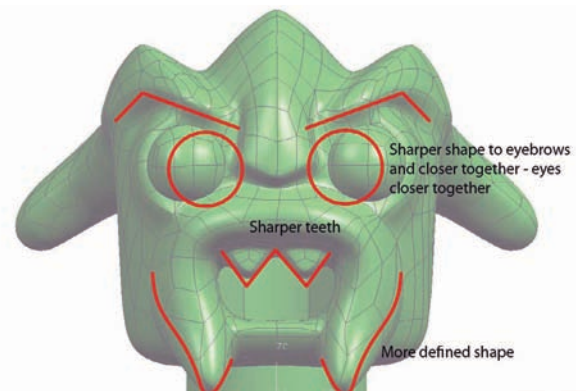
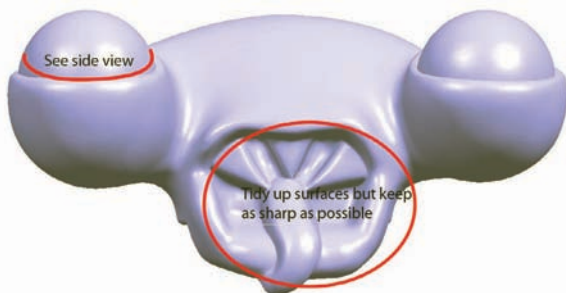

Kranxx 3D prototype with comments.

LEGO Group



Jens Nygaard Knudsen

The Truth About SPACE!

Article by Mark Stafford

Photos from Niels Milan Pedersen's personal LEGO archives

Everyday I work alongside Niels Milan Pedersen in the LEGO space area of the PMD Design building in Billund. Niels has been with the LEGO Group for over 26 years and sculpted the LEGO horse, crocodile, monkey and skeleton amongst many other parts. He's a living history of LEGO Design. It's rare we (the LEGO set designers) come up with a 'new' idea without Niels pulling out a folder from the 1980s and showing us a previous version of it! However Niels has always told me he is just a youngster and the true historic figures had moved on. Recently he invited me over to the LEGO Idea House to meet with one of these people; his old boss Jens Nygaard Knudsen, creator of the mini-figure and LEGO space!

Jens worked for the LEGO Group from 1968 until his retirement in 2000. "Thirty-two years I worked with LEGO" he told me proudly. He saw the job advertised in a Danish newspaper in 1968 when the company was looking for model builders. His first task was to build hundreds of small LEGO Town cars in many different colors, these were along the lines of the 605 Taxi and the 420 Police Car (the author's first ever LEGO set!) and he designed much of the early 'Legoland' branded LEGO Town sets.

As time passed Jens moved onto bigger sets including the Fire Station, Police Station and Hospital, and it was his idea to incorporate rooftop heliports - "A great success. Still an idea being re-used today." he says. There were just three or four designers at the LEGO Group in the early 1970's so Jens, along with his colleague Bent Irving Andersen, also helped to develop the early electric train system (blue tracks/ white sleepers) "I built lots and lots of trains!" he explained. On a quick trip around the idea house, he lays claim to the 182 and 7710 trains. "I made all of the train chassis elements and the wheels too." He also made most of the 'Basic' sets of the time, culminating with sets 733 and 744, the latter really shows the "Futuristic models" Jens was trying to make, "With lots of functions and technology incorporated."

Jens' first Space sets, indeed the company's first space sets, were the 358 Rocket Launch-pad and 367 Space Module with Astronauts. It was difficult at the time to make a lot of color changes, and grey LEGO elements were not considered bright enough to be the main color in a toy, after some experimentation he considered that blue looked technical enough and the sets were produced with this color predominant. Of course this color would later be retained for the LEGO space line!

Around 1975/76 the design group was re-organized and split into three groups, a concept/forward planning team, the product development team and a support team to make the building instructions etc. Jens initially found this frustrating as he always wanted to do everything. "He still has the energy of seven men!" pipes in Neils at this point. But the advantage was finding lots of time to concentrate on new ideas and concepts, including a smaller 'Legoland' sized counterpart to the bendy armed LEGO figures (also known as Homemaker figures - Editor) and his favorite idea: a LEGO space theme. The two concepts actually developed together and the "Mini-Figure" was first used in the conceptual Space models! "We chose the yellow faces to be racially neutral." explained Jens.

The LEGO company wanted to rush the mini-figure into the marketplace as quickly as possible, "They wanted to have '10' Danish Krona (About \$2-00) sets that featured the new 'LEGOMen' out in the shops before anyone else beat us to it!" Thus the Town and even the new Castle line were put out in 1978 with the newly created mini-figures even though some

of the sets could not fit the new figure into them! It was a marketing strategy to hold back the strong LEGO Space line for a secondary release and to be a big surprise for the Nuremberg Toy Fair in 1979. This despite Space being the first completely finished mini-figure based line in 1976!

Unfortunately one of the LEGO design team 'defected' to the competitor building block company of 'TENTE' and they began to work on a space line, which forced the LEGO Group's hand. Determined to be the first 'Space' construction toy onto the toyshop shelves the LEGO Group had to rush release of three of the LEGO Space sets out into the American market in 1978, more than six months before originally planned. "He left before I created the crater-plate baseplate though, so their space sets, which looked a lot like ours, were all built on several layered



A classic space remote controlled vehicle from 1985.



A Blacktron concept dated 1985, perhaps an early development of Blacktron 2.

plates and were just not as cool as ours." Jens chuckles.

In 1979 LEGO Space arrived properly to huge fanfare at the Nuremberg Toy Fair and was voted "European Toy of the Year 1979" and a full worldwide release followed. Every set in the first wave of LEGO Space was designed by Jens and he also created all of the new elements. The success of the line helped LEGO to hire 500 extra production employees that year and earned Jens a promotion to Chief Designer.

"When we started LEGO Space it was difficult to make bricks in a lot of new colors, or to make new parts. The helmet had to work in space, castle and town for example." Explains Jens: "The colors of the early space sets were a result of this. If we had a lot more new colors then the wings would probably have been white, not grey, in those early ships. We started with



Early Space Police concept from around 1986.



M-Tron walker, 1987, note the early greebling.



M-Tron transforming vehicle, 1987.



M-Tron crane, 1987, this was before the magnets were involved in the theme.



M-Tron 'powersuits' from around 1987.

only Red and White figures, we considered the red ones to be the 'bad' guys, and that they were two competing factions." Jens had wanted a brick that said 'LEGO Space' to be printed and be in all the original sets, much like the earlier 'Legoland' bricks had been in many of his town sets, but again this was a change too many.

"The space logo was made by Hjalmar Nielsen, his first version had a lot of stars around it too, and was beautiful, but this was considered too flashy so the stars were removed!"

I asked about the colors of the classic spacemen and if they had any particular significance to the designers. "The original two colors were explorers, yellow were scientists, blues were technicians or mechanics and I guess the black were warriors, but we were not allowed to make a big deal out of this. We were not allowed to make war."

Niels nods in agreement at this point, "There were a lot of disagreements about the aerals and other elements that pointed forwards on the ships because of the 'no war' policy." Jens takes over, "We were not allowed to make weapons, and these things we built looked aggressive, so there were a lot of 'radar dishes' added and 'sensor probes', but to us they were really guns!" In fact, there was also a fair bit of controversy about making black suited spacemen at all, as some at LEGO thought they were too threatening and Jens had to use the Town police and firemen to prove that hero figures could indeed wear black!

The color change away from the blue/grey/transparent-yellow sets was simply to refresh the space line; the old colors had been done and the design and marketing teams wanted the second line up of space to be fresh for the customers (shops) and consumers (kids). Several color combinations were considered, with red/black, black/white and black/yellow being frontrunners, but the management chose the blue/white with transparent blue windows as the way forward. Jens still seemed disappointed in this choice "I wanted some silver elements, and maybe the black and yellow color scheme, later I made Blacktron using that though!" But he admitted the blue/white combination did allow a nice continuation from the first round of the space theme.

The space line pushed forward many innovations at the LEGO Group, transparent colors (other than clear) were first made for space, there were opening hinged doors and roofs with vehicles inside, ships that were modular, 'Light and Sound' bricks were created for space, the monorail invented, raised and multi-colored base plates were also first made for the LEGO space lines, and so much more. Jens feels the space sets explored and expanded a lot of the company's technological frontiers.

"I remember we all even made a stop-motion space movie in the late seventies, Kjeld [Kirk Kristiansen] might still have it. We all flew to Copenhagen and had a premiere in a cinema there!" They laugh and break into Danish for a few minutes, and then tell me they won't translate that as there was no way I could publish that story! Then they laugh again. "We also flew to Copenhagen to see Star Wars when it came out, but it didn't influence the early space sets as we had finished them in '76, and the very first versions I did were back in '73." said Jens.

Jens hired Niels in 1978, partly as they found they had the same hobby of sculpting and molding tin figures (a hobby both continue) and together they worked on the LEGO space lines, though Niels was heavily involved with the castle line too. The space line continued to evolve and LEGO felt the need for a large re-vamp of the line. "We made a lot of new elements end



The M-Tron we almost had. A variation of LEGO's M-Tron theme dated 1987.

colors for the Futuron theme, but when we tested with kids, they were un-impressed, it was the mini-figures new diagonal print still with the space logo on it that all of them were impressed with. Kids like this kind of detail." Says Jens.

Space had become a core product line at LEGO and through the eighties Jens continued to work on every space line; "Blacktron, Space Police, Magna-Tron (M-Tron), Blacktron 2, more Space Police and Sea-Tron."

"Sea-Tron?" I asked, "Is that Aquanauts?"

"Yes." Said Jens "It was underwater-space. Spaceships on a water planet."

"Like Ice-Planet later?" I asked

"Precisely. It was an alien planet where the astronauts were underwater, it's LEGO space though."

"Wow. That's going to surprise a lot of fans, a 'new' old space theme!"

During this time Jens worked with Peter Bolli in Switzerland to create new colors, the light and sound bricks and later the monorail. The monorail was intended to be a much larger theme, and several other elements were made for the tracks and the switch-points but the market for the monorail was not what was expected and these ideas were shelved.

They also tried alien mini-figures around the M-Tron to 'Sea-Tron' period, Niels sculpted them, with a cool spine and webbed feet but management felt it was not right at the time and aliens would have to move forward later. However some of the old



An alien explorer from 1988.

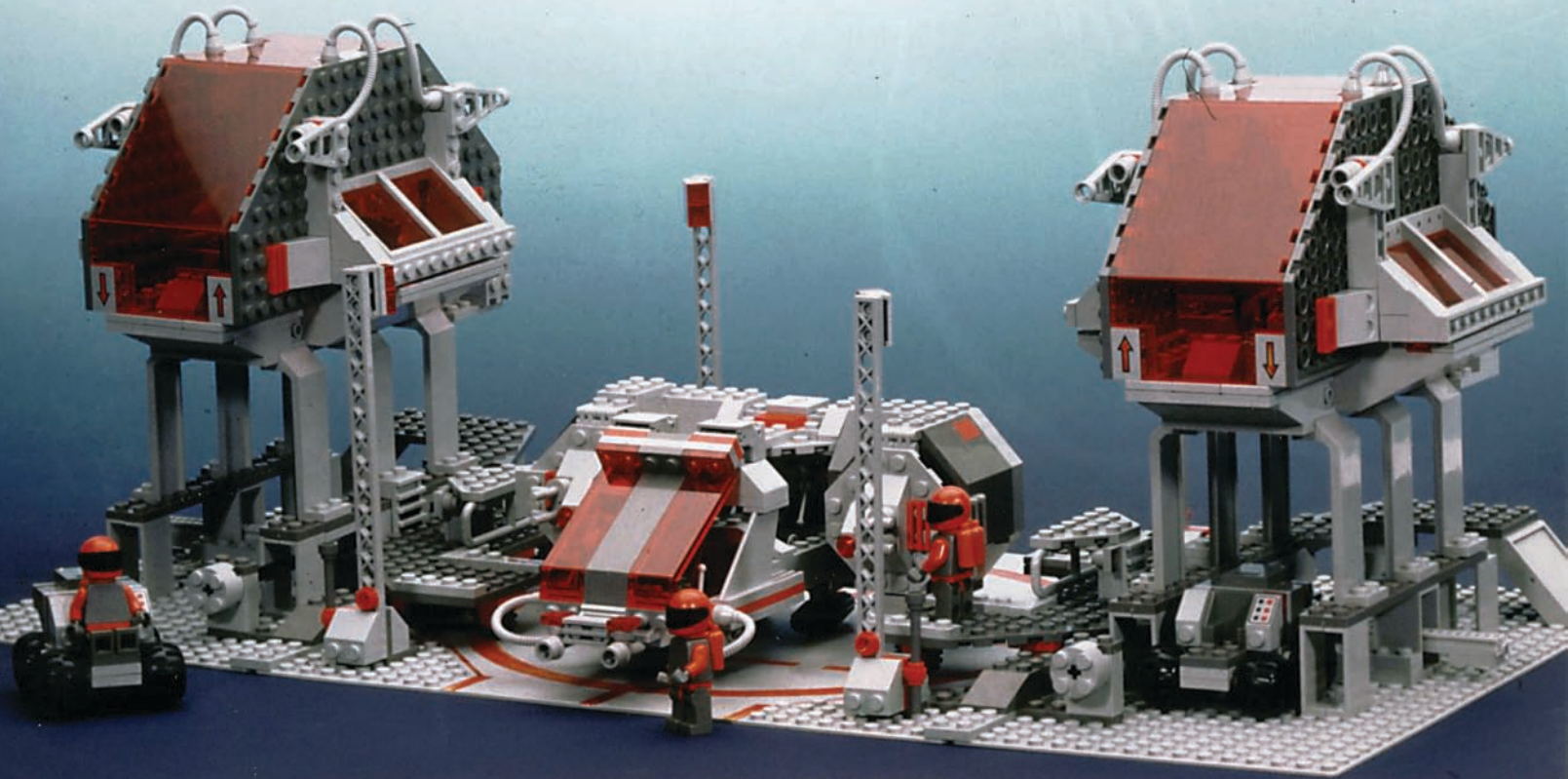

An unused AFOL like space concept from 1989.

A concept dated as 1989, but with many ideas and colors that would later be used in 2001's 'Life on Mars' LEGO theme.

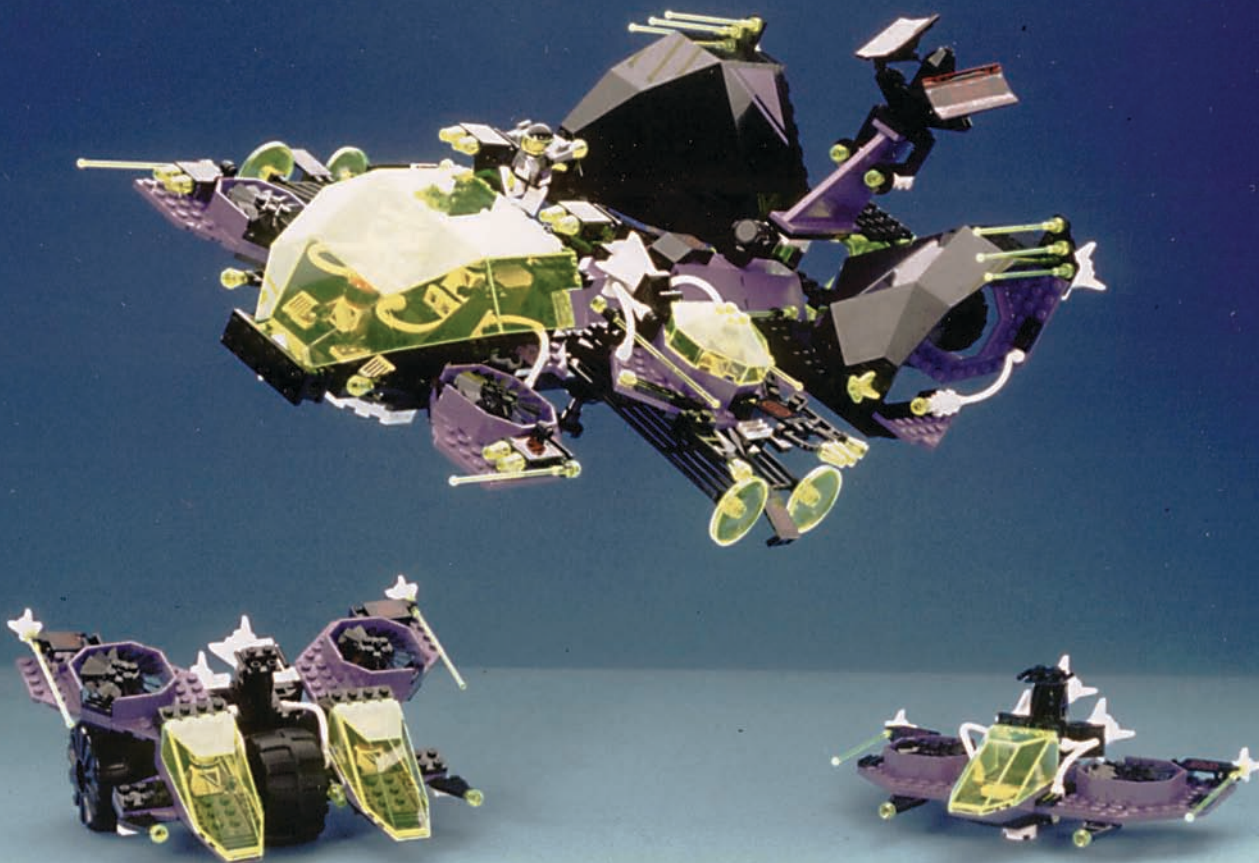

drawers in the Design building still have these early alien concepts in them.

That was about the end of Jens' involvement in LEGO Space (some lines were held back by marketing and this may explain why the order Jens remembers designing them in does not match up precisely with the order in which the lines came out). A new design team took over space after M-Tron, and the same new team also developed the incredibly popular Adventurers line. Jens gives the impression he feels it was left in good hands. He himself moved on to work on future concepts and technology and eventually retired from LEGO in 2000.

Jens has been introduced by some of his ex-colleagues to many of the fan models of Spacecraft on the internet and has seen: "So many fantastic models by so many builders!" In retirement Jens has continued to use LEGO at home and builds LEGO trains, he has a large collection of 'Techno' [mechano] cars and continues to sculpt his own tin figures.

Niels still works for LEGO and has recently designed the Space Police 3 set 5971, 'Gold Heist' and made the preliminary sculpts of all of the new Alien Mini-figure heads based on the concept art!

Working here at LEGO it's pretty cool when you mention a favorite childhood (or adult) LEGO set and one of your colleagues owns up to designing it, but though amazing, it has never left me as star struck as I was meeting Jens. While he, Niels and I talked I was often left lost for words, not knowing what to say next and all I really wanted to do was thank him for all of the best toys of my childhood and let him know how much I appreciated it. So apologies if I didn't ask everything my fellow adult LEGO fans might have wanted to know. 



Sea-Tron monorail from around 1990.



One of several M-Tron era aliens by Niels Milan Pedersen that never made it to market.

Sea People, another Sea-Tron concept from the early 1990's.





You Can Build It

MINI Model

Classic Space 924 Space Cruiser

*Design and Instructions
by Christopher Deck*

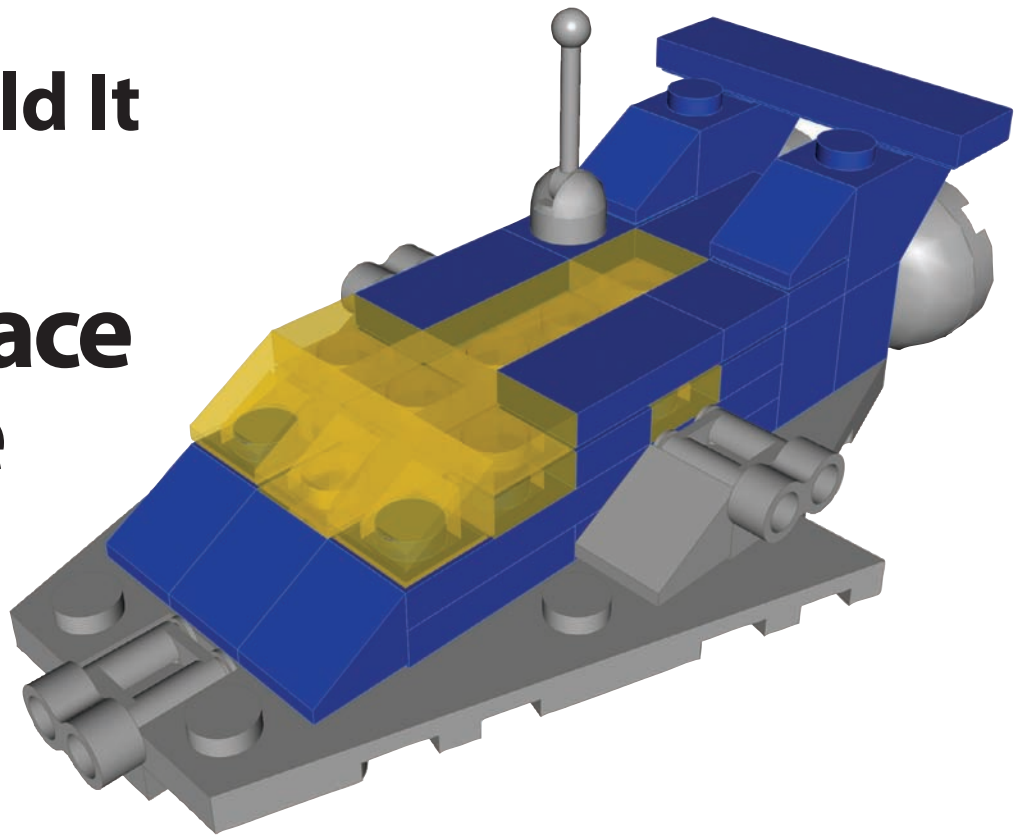

Hello again dear fellows, I'm glad to return for this special issue of *BrickJournal*. Thirty years ago, the minifigure discovered LEGO space. The brave little men broke the final frontier and went where no minifigure had gone before. The first ships of the fleet included a series of similar designs: the small 918 *Space Transport*, the medium-sized 924 (487 in the US) *Space Cruiser* and the gargantuan 928 (497 in the US) *Galaxy Explorer*. Not many of these are still in service today, but several of today's LEGO space captains might have a small model of them in their display cabinet on the bridge to remember those glorious events that took place thirty years ago.

Happy building and see you next time!

Yours, Christopher Deck

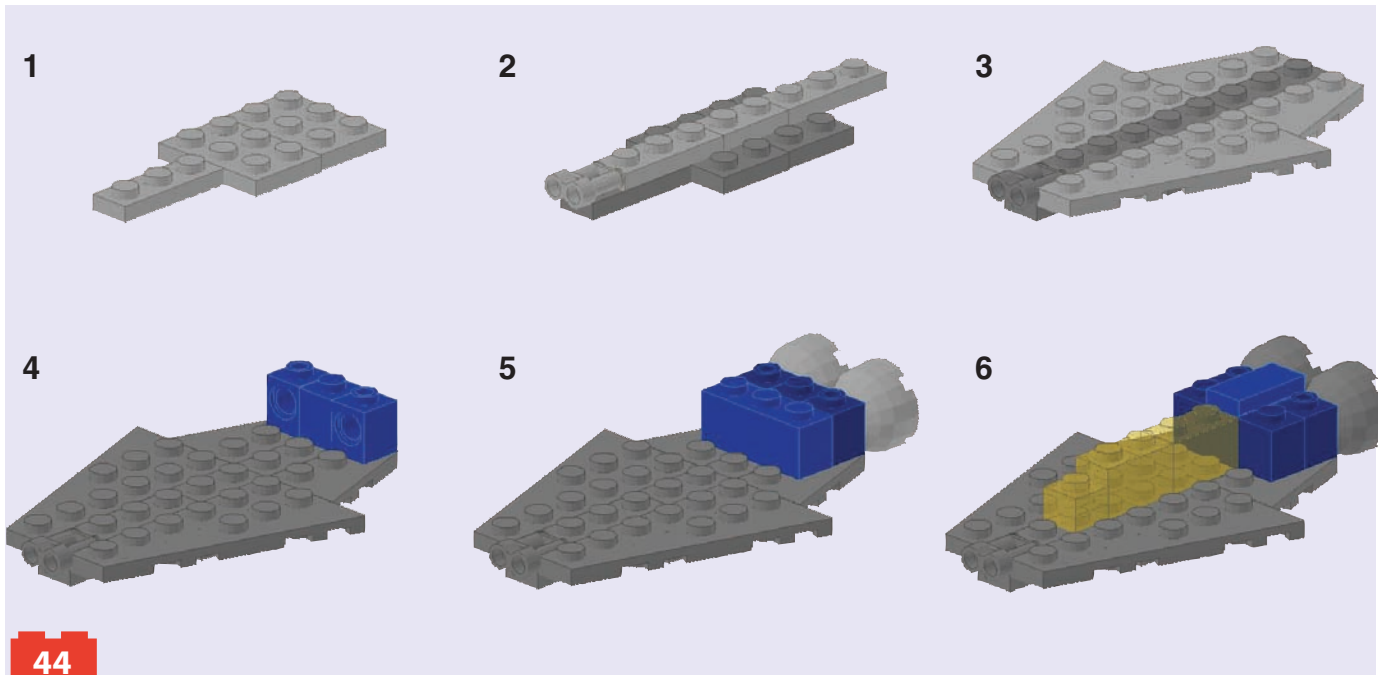

7

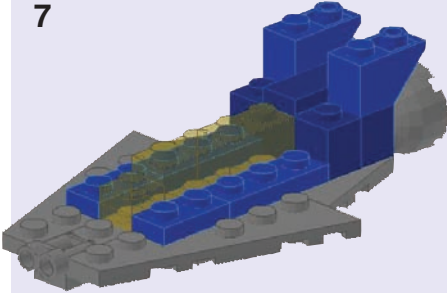

8

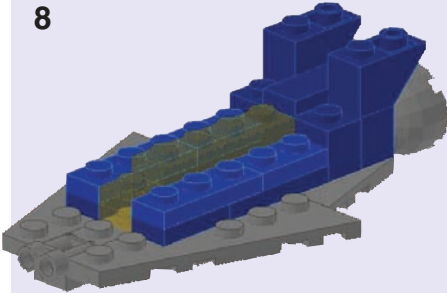

9

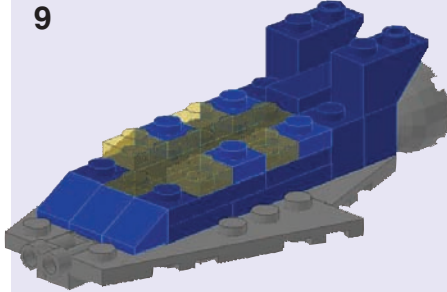

10

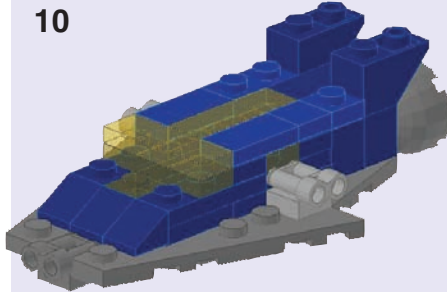

Numb.	Color	Part	Description
1	Blue	3005.dat	Brick 1 x 1
2	Trans-Yellow	3065.dat	Brick 1 x 2 without Centre Stud
1	Blue	3622.dat	Brick 1 x 3
2	Light-Gray	30367.dat	Cylinder 2 x 2 with Dome Top
1	Light-Gray	4593.dat	Hinge Control Stick
1	Light-Gray	4592.dat	Hinge Control Stick Base
3	Light-Gray	30162.dat	Minifig Tool Binoculars Town
5	Blue	3024.dat	Plate 1 x 1
2	Light-Gray	3024.dat	Plate 1 x 1
6	Trans-Yellow	3024.dat	Plate 1 x 1
5	Blue	3023.dat	Plate 1 x 2
1	Light-Gray	3023.dat	Plate 1 x 2
4	Blue	3623.dat	Plate 1 x 3
3	Light-Gray	3623.dat	Plate 1 x 3
2	Light-Gray	3021.dat	Plate 2 x 3
5	Blue	54200.dat	Slope Brick 45 1 x 1 x 2/3
2	Light-Gray	54200.dat	Slope Brick 45 1 x 1 x 2/3
3	Trans-Yellow	54200.dat	Slope Brick 45 1 x 1 x 2/3
2	Blue	3665.dat	Slope Brick 45 2 x 1 Inverted
2	Blue	6541.dat	Technic Brick 1 x 1 with Hole
1	Blue	3070b.dat	Tile 1 x 1 with Groove
4	Trans-Yellow	3070b.dat	Tile 1 x 1 with Groove
3	Blue	3069b.dat	Tile 1 x 2 with Groove
1	Trans-Yellow	3069b.dat	Tile 1 x 2 with Groove
1	Blue	2431.dat	Tile 1 x 4
1	Light-Gray	43723.dat	Wing 2 x 3 Left
1	Light-Gray	43722.dat	Wing 2 x 3 Right
1	Light-Gray	54384.dat	Wing 3 x 6 Left
1	Light-Gray	54383.dat	Wing 3 x 6 Right

11

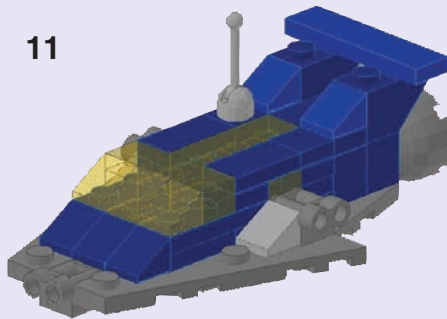

12

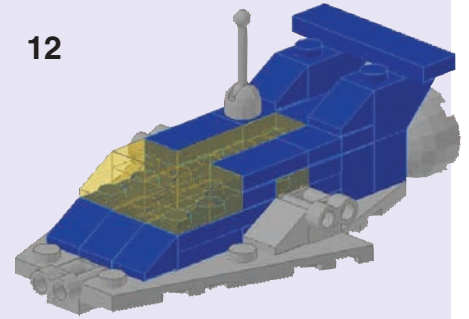



PIRATES



The Return of the Pirate Sets



*Article and
Photography
by Geoff Gray*

Pictures and comments from Cameron Fields are printed with the consent of Cameron's parents. Some images and graphics are Copyright the LEGO Group.

Introduction

Several years ago (I believe it was 2001), I was attending BrickFest® in Washington DC. For those of you who are not familiar with BrickFest, it is an annual convention where people from all over the world come together to celebrate the love of the brick and building with LEGO elements. There were groups that focused on specific themes, such as space, trains, castle and pirates, as well as people who loved any of the themes and all LEGO items in general (I am definitely in this group). I really was intrigued by some of the pirate sets I saw and wanted to learn more. Unfortunately, the LEGO Group had stopped manufacturing the line of sets around 1997 and most sets were gone from public circulation. I decided to go through eBay and ended up getting most of the big ship sets. I would build them with my younger stepson, (Cody Marple), and we'd play with them. He really loved the cannons that actually fired the 1x1 round bricks. He told me he was going to save his money and go buy a set of his own. He was heartbroken when I told him how hard it would be to get one.

In 2001, the LEGO Group released a remake of the "Armada Flagship" (original #6280, remake # 6291) and I readily snapped up one. It was cool, but it wasn't nearly as fun as some of the bigger sets like "BlackBeard's Bounty" (set # 6243). Oh well, this is the nature of sets from the LEGO Group and it does allow for them to create new lines and sets, which continually challenge people's imagination. It didn't have any of the shooting cannons, so I still had to pull some from my older sets to let my boy have his fun.

“By the time I left, I was very excited about the release and I was already trying to put together a story to tell my wife why I needed to spend the money on these.”



Cameron and Debbie get to work on building “Shipwreck Hideout”

I usually keep up with all of the new lines of sets that are released each year, but the fall of 2008 had been very busy for me with work, so I was a little behind. I was shopping for Christmas presents one day when I found myself in the building toy aisle (there’s a shocker). I almost fell over when I saw a bunch of Pirate sets. My first reaction was that they’d be cute but not nearly as good as the original. Then I started studying the boxes. By the time I left, I was very excited about the release and I was already trying to put together a story to tell my wife why I needed to spend the money on these. I couldn’t come up with anything that would satisfy her during this time of giving, so almost abandoned the idea. I finally decided to approach the company and ask if I could review the line for *BrickJournal*. Well, a few weeks later a package showed up at my front door and when I opened it, I was staring at the entire line of the new Pirates sets. I let out a yell that caused the dog to start barking and my kids flying into the hallway to see what was wrong with me. Then the fun began.

The Build

I started with the smaller sets and the build process began, complete with taking pictures, writing notes, and dreaming about the fun I would have when all of the kits were assembled. I limited myself to a maximum of one kit a night (some took more than one night) just to make the fun last. I also asked my neighbor’s son (Cameron Fields) if he would like to help out. He is 6 years old and so I thought he would enjoy it and he would be a good measure of how accurate the age range defined by the LEGO Group was. He readily agreed, and we set off on his kit (“Shipwreck Hideout” set #6253). Cameron was very excited and even his mom Debbie got into helping a little. She is fighting the urge to get sucked into the LEGO hobby, but I have gotten Cameron completely hooked (as well as Debbie’s husband), and I’ll bring Debbie around <grin>. They worked on the kit until Cameron had to go home for bed since it was a school night. I sent the rest of the kit home with him so he could finish it. I got it back a couple of days later, along with Cameron’s assessment, which is in the “Findings” section of this article.

Meanwhile I continued to dive through my kits. I was loving a lot of the new elements, as well as the collection of minifigs and accessories included. I feel these are very important elements for sets that are designed more for playtime. I finally got to the pinnacle of the series, "Brickbeard's Bounty" (set #6243). As I built this one, I was amazed at the detail and playability. Once I was done with this set, I had the whole lot sitting on the dining room table and was ready to start playing. I spent an entire evening doing this, much to my wife's dismay (I travel a lot for my job so when I am home, she would like me to help raise our kids and keep the house going. I love you honey, and I promise that in the future I will promise to help out more. I just can't promise that I will follow through, especially if the LEGO Group continues to release new themes like this.



Durability



I had Cameron stand on one of the partially built sections to prove how sturdy the design and craftsmanship of these toys are.

I have often talked about the strength and resilience of LEGO elements. Their ability to stay together is called "clutch power" and the tolerances that the LEGO Group defines for this are extremely tight. This allows the bricks to hold tightly, yet still be able to easily separate. The molding process and the pressure used during molding also insure that the elements can handle lots of stress. Other brands of building blocks cannot hold up to the stresses that LEGO brand elements can handle.



Findings

Now that I have calmed down, let me try to offer a fair and unbiased opinion on this line of sets. My review may sound like an endorsement, but I promise that it is not, and I promise that the opinions are well warranted (and these promises I will keep).

The packaging and artwork on the boxes is first rate. I have seen the LEGO Group really step up the art work on the sets and this is no exception. Good job. I found only one flaw in the artwork on the boxes. "Cannon Battle" (set # 6239) has a picture of the minifigs with the pirate having the clean shaven head, but the instructions show this minifig using the head with the goatee. But hey, if that's all they missed, then congrats. This type of misprint doesn't matter a lick since I know very few people who care how the minifigs are assembled. As a matter of fact, when Cody builds a set, he dives right into the minifigs without even looking at the instructions.



Kids love little details, and fun things to discover. This line has introduced a new animal to the lineup; a silver fish (I think this is the first series to have it). "Pirate Survival" (set #8397) has a pirate holding the fish on a stick over a small campfire. "Loot Island" (set #6241) has the same fish set on a spit over an open flame. "Soldier's Fort" (set #6242) has a little stick of dynamite that a pirate is trying to sneak into the fort. There are lots of jewels, gold, weapons, creatures, and items that shoot, fire and move in all kinds of ways. There are hidden area, trap doors and other items to make playtime really fun.



"Soldier's Fort" uses the LEGO Group's modular assembly that allows you to connect the different sections any way you'd like. Kids can set-up their fort differently each time they play.





The boxes stick with the re-sealable side flaps to make storage easy (I mentioned this in an earlier review, and I am truly glad to see this as a regular feature). The bigger boxes are sturdy enough to store most everything safely. When I was done with the sets, I broke them down completely and got 90% of everything into the “Brickbeard’s Bounty” box.

All six cannons in these sets will fire the 1x1 rounds bricks. The original Pirate series had some cannons that would not fire.

(NOTE: The image here is from the downloadable LEGO PIRATES comic books.. <http://pirates.lego.com/en-us/downloads/comics.aspx>)

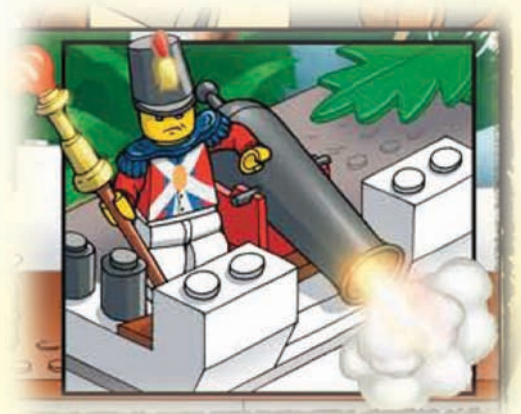

The construction of the masts and yardarms is more durable and simple than in the older sets. The new ship uses long flexible tubing for the yardarms, where the older sets used plates, which might separate during play.

The aft portion of “Brickbeard’s Bounty” is extremely detailed and is removable. The bowsprit does not have an actual forestay (the older ships used string to act as a forestay), but instead uses the jib sail as a “pseudo” forestay. The bowsprit does not include a dolphin striker or the sidestays, but the realism is not lost by the exclusion of these parts. The figurehead on the bow is a mermaid and really adds to the overall effect.





The final assembled collection, ready for action

Cameron's Feedback

Cameron did not have a lot of feedback. He was too busy enjoying the kit to think about silly reviews (which is good feedback in itself). He did say he found the kit very entertaining and had fun building it, but he said there was one thing wrong. "The hat on the skeleton shouldn't be there. It doesn't look good." Well, that's the beauty of LEGO toys. Since he didn't like the hat there, he just took it off. Problem solved.

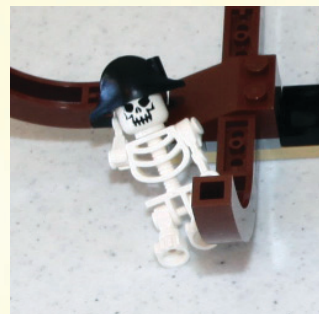

I found (as is typical with LEGO instructions) that the steps were easy and clear. I realize in this day and age the need to be clear about potential hazards with items that could be considered unsafe

(although I had access to lawn darts when I was a kid and I survived). So do the teams that put together the instructions. Since the cannons that come with these sets really fire 1x1 round bricks, the company is worried that someone



might get shot in the eye accidentally, and the LEGO Group believes that all instructions should be clear to everyone without having to use any words, so they include a graphic depicting the danger.

It is effective, but I couldn't help but chuckle when I saw it. The face looks like something you'd see in a Saturday morning cartoon.

I also noticed the LEGO Group's continuing effort to help the planet by promoting the ability to recycle bags. I am not a recycle freak, but I do believe in trying to help out. Plastic bags are seldom marked with their ability to be recycled, and most of the ones that are marked use a small copy of the universal symbol. The bags from these sets display the symbol as a reminder. 



PIRATES

About the author:

Geoffrey is the photo editor for BrickJournal and a lifelong fan of the brick. He has attended and presented at seminars, had his designs win national competitions, teaches creative play around the community and has participated in several beta programs with the LEGO Group.

Facts

There are 8 sets in the theme.



There are a total of 29 minifigs



There are a total of 18 creatures



There are a total of 43 weapons



There are a total of 1567 elements

All 8 sets can be purchased for \$232.92



LEGO® Power Functions Train Development: On Track with LEGO Fans

Article by Megan Rothrock
Photography
by Gaute Munch

Power Functions (PF) is the LEGO Group's new electric-powered building system, which allows the builder to add motors, sensors, infrared remote control, lights, and interaction into their LEGO models. BrickJournal had a chance to meet with Mr. Gaute Munch, the Technology product manager at LEGO headquarters in Billund, Denmark and talk about the new Power Functions elements.

"When the LEGO Power Functions System was developed, we looked at many different uses, and the needs for all of the building systems. It needed to be able to be used in a Technic or a Creator model, just as easily as a LEGO train model," explained Gaute.

From the very beginning, the development of the new LEGO train platform has had a lot of AFOL (Adult Fans of LEGO) involvement. The company set up an online forum very early on so they could receive input from some of the AFOL Train Fans and exchange ideas about the possibilities of using Power Functions with trains. The forum also provided an opportunity for AFOL's to suggest other new elements that could be useful.

The first workshop was held from 5th to 8th of February in 2007. The LEGO Group invited four AFOLs to LEGO headquarters in Billund Denmark: Heiner Berg (Germany) Mark Bellis (United Kingdom), Philippe Hurbain (France), and Stefan Vorst (Germany).

The Beginning!

"We knew that the Power Functions System had a big potential to be used with LEGO trains. However we don't build a lot of trains, and felt we should invite some of the fans who are skilled in that are," Gaute said.

During the workshop the fans had the chance to work hand-in-hand with LEGO Designers and experiment with Power Functions, as well as come up with ideas for new elements for the platform.

A wide variety of building was explored to find other ways of incorporating Power Functions into LEGO models. AFOL Heiner Berg, from Germany, built off-track assets, including a big crane that could pick up a box from one train car and load it on to another. The train was powered by the PF battery box and could be controlled via remote control.

Some of the other workshop participants built a new train crossing with sensors that could automatically detect a train and can raise and lower when it drives through. Part way into the workshop, though, they discovered that the current Technic Battery Box was too large to be built into most train designs, and so the immediate need was for something smaller.

The conclusions from this first workshop were that the LEGO Power Functions modular remote control system offered a lot of exciting new possibilities for the train area. New PF components were needed, however, to make it feasible: a compatibly sized battery box and a remote control handset capable of variable speed control.

The second workshop was held a few months later, from April 23rd to 27th 2007.

A few LEGO train Fans from further afield were invited to attend: Stefan Vorst (Germany), Holger Matthes (Germany), Steve Barile (United States), Didier Enjary (France), and Timothy Gould (Australia).

Metal no More!

Just before the second workshop was held the LEGO Group made the decision that the 9-volt LEGO train System was going to be phased out. On the first day of the workshop, Gaute gathered everyone together and announced that there would no longer be metal on the LEGO train track. He saw everyone's jaws hit the floor and the whole group stared at him with wide eyes. Gaute explained that the future train tracks would be the ones without metal used in the RC train (fully compatible with 9V tracks) and that future train control would be built with LEGO Power Functions.

The purpose of this workshop was to further explore train solutions using the LEGO Power Functions platform. Gaute presented the new Power Functions System, and explained that with it there could be greater possibilities than with the old 9V system. Although initially skeptical, everyone knuckled down to work and began to set their minds to developing innovative substitutions for the existing abilities of 9V.

They also explored different train track layouts, and asked themselves what new advantages could be created with the metal removed from the tracks? The idea of a bendable or flexible track was put forward. If it was possible to create customized curves on corners it would allow for a whole new track layout. The first prototypes of the flexible train track were made and the results looked very promising. The final track element would naturally require a long development, but the participating AFOLs made it clear how high the demands on such the flexible track would be: It must be able to support different types of trains, sizes of wheels, different speeds and it MUST NOT be prone to derailling!

A new battery box was still required, and after much discussion they decided that a rechargeable version was the best option. The team also came up with dimensions of 8 stud x 4 stud x 4 stud modules. They then built brick prototypes to see how they could fit a block of this size into a train.

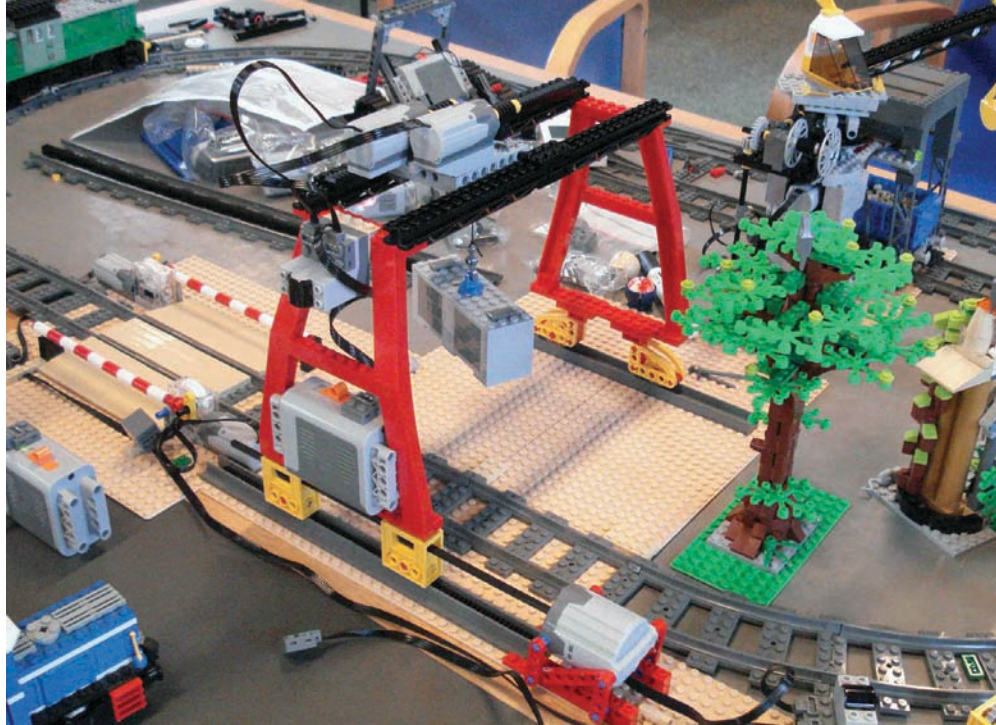

A freight crane controlled with LEGO Power Functions capable of picking up a container and loading it onto a train.



A bulk loading crane: the arm raises, lowers and swings to the side to scoop up cargo and load it.

"The feeling at a LEGO workshop is like being in a Holy Place. You meet the top designers and top AFOLS from all over the world, and you try to give your best. And you always remember this time maybe as the best time in your life."

- Heiner Berg, Germany

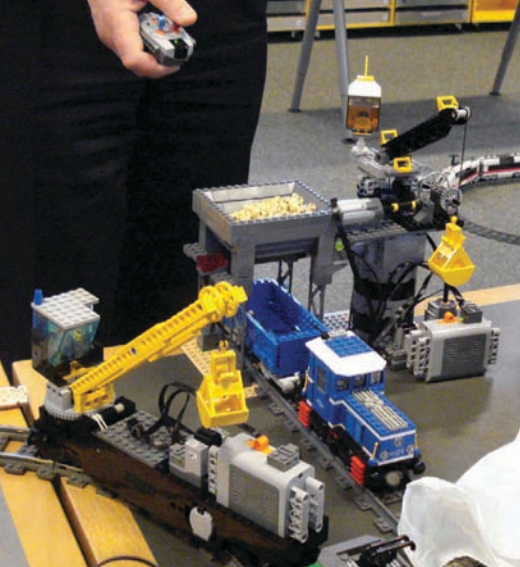

Self-loading coal funnel and crane built by Heiner Berg. This was part of the off-track assets resulting from the first workshop.



Prototype of the first version of flexible track it was developed during the second workshop allowing the team to give valuable feedback to the LEGO Group.

Holger Matthes works on an off-track asset.



Serge Belsack building a train inspired by the TEE train used in Belgian other parts of Europe.

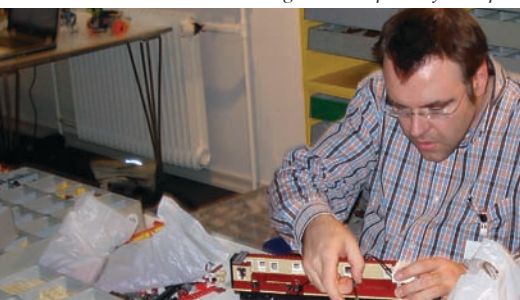

Since the Power Functions system is not limited by power supply to the track only, it allowed for a new type of interactive train layout: single crossings with sensors, cranes that could load and unload cargo and other external functions.

As the workshop came to a close, it was decided that the flexible train track was a good solution for new and exciting train layouts. They had also discovered and concluded that recharging the train was the correct solution, but one that would require an incorporated speed control within battery box. They discussed if on track charging or setting up a charge point on the side of the track was the best solution. It was suggested that a third party company like Hi-Technic might be able to invent a charging solution.



International AFOL Team and the LEGO Power Functions Team at the Idea House.

On a New Track:

The third and final workshop was held the week of November 26th – 29th 2007 This was the largest workshop with 11 AFOL train fans invited from seven different countries: Heiner Berg (Germany), Didier Enjary (France), Steve Barile (USA), Ben Beneke (Germany), Serge Belsack (Belgium), Jason Railton (UK), Huw Millington (UK), Henrik Thrane (Denmark), Ludo Soete (Belgium), Johannes Wind-The Netherlands, and Megan Rothrock (Denmark).

The final workshop was divided into two parts. The first focused on how LEGO Power Functions could enhance a train system. The second part focused on how to best aid the beginning development of the Shop at Home train model, while exploring ways of incorporating PF into the model in a modular way. Prototypes of battery boxes, controls and motors that resulted from the previous workshops were made available for everyone to test and build with. The idea was to build

“Building MOCs and designing a LEGO set are two completely different things. Building a MOC you can do all by yourself, you don’t have to care about using old ‘70s elements or illegal ways to connect bricks. At TLC there are more restrictions and you have to work in a team. You only might work a week on a task and then someone else takes it over and carries on with the work.”

- Holger Matthes - Germany

a minifigure scale LEGO train model with no motor, but adaptable enough to incorporate the LEGO Power Functions, allowing for more playability.

Driving the train:

The first challenge was exploring if PF could indeed be used to drive the

“I like to think we expanded the ideas of LEGO’s designers as to what could be achieved, and I was happy to give up all my best ideas. I’d much rather see them used in an official set than just a one-off build of my own. I remember them asking what would make us want to buy a PF train set, and saying the question should be what would make us want to buy four of a train set.”

- Jason Railton - UK



The AFOL team takes a rare break, and discusses some of the LEGO train Models they have brought to the workshop.



Ben Beneke concentrates on his steam train.



Huw Millington contemplates how to fit all of those new PF components into his engine.

train. The Medium Power Functions motor and the extra large XL motor (as used in the Technic Bulldozer set) were used to see how compatible they could be within the constraints of building a train. There was also the challenge to see how much payload (weight) a train was capable of pulling. Experiments were done using LEGO weights on a train, and running it at different speeds, and around corners, to see how much payload the motor could take before the wheels spun on the track. The AFOLs discovered that if rubber silicon bands were added to the wheels they rode better on the track and had much more grip.

The participants also got their hands on the first plastic version of the flexi track and began to explore its use in developing new track layouts. Different bogies (the swiveling platforms wheels that are attached to on the bottom of train carriages) were also built incorporating PF.

Another challenge was finding the best way to conceal the Power Functions into a train model. They built many different types of trains, explored building in gear functions, and exploring new ways of mounting motors and creating a power train. LEGO Designer Jamie Berard (who was slated to be designer of the new train set) also met with the fans to discuss building techniques for LEGO trains and got suggestions for what LEGO train fans might desire or look for in a LEGO train set.

It was a very fun and intense four days — everyone was so focused on building, that they even didn’t notice when it was time to take a break. They didn’t want to stop for anything, including dinner, so the company ordered food in so the fans could squeeze in a few more hours of building time!

The greatest success of the final workshop was that the company was now convinced that incorporating Power Functions into train sets had a big potential for future development, which may include many different types and eras of train



Ludo Soete begins to build a diesel engine.



Exploring new ways of expanding the LEGO train platform during the second workshop.



A small steam train powered with PF, though it is small it is mighty fast! This model was built by Heiner Berg.



A model of the Union of South Africa steam engine powered by PF (It's actually his fathers favorite engine) built by Jason Railton.

design, more interactive layouts, improved speed controls, and other future innovations.

After this third workshop the LEGO Group 'closed its doors' and got down to work. They wanted the final result to be a surprise for all of the Train AFOLs who had been involved in the development, although they also did work very hard to keep the AFOL Community up-to-date with official Train Communications via the LEGO Ambassadors and posting on LEGO fan forums and LEGO.com.

Pulling Into the Station:

The resulting product from all of the thought, creativity, and tireless hours from everyone involved is the LEGO set # 10194, The Emerald Night. All of the fans that participated in these workshops are just as proud as Jamie of the end result. It's great to see a little of everyone's vision in the final model. Having attended the third workshop myself, I can say that it was an experience of a lifetime, and a very positive experience for everyone involved.

The Power Functions website (which was launched in 2008) is a place for all AFOLs (and kids of course) to share their creations and show everyone how dynamic they can become by adding Power Functions to them!

<http://powerfunctions.lego.com> 

"If TLG wants to make a set that is interesting for the target group, they need to learn about what AFOLs expect from a LEGO train set. I think that all the positive reactions to The Emerald Night set makes it clear that this works. The focus group was adult train AFOL's but I think a lot of kids will also buy this set."

-Johan Wind - the Netherlands

BrickJournal asked Jamie Berard, LEGO set designer for the Emerald Night, what he got out of the third workshop.

How would you define your role towards the AFOLs as a LEGO Designer at the workshop?

My role in the workshop was two-fold. First I really wanted to learn as much as possible from the AFOLs about how they like to build trains. It was important to find out what are the most valuable pieces, colors and engine types. Also, I wanted to challenge the idea of what LEGO trains 'could' be rather than assuming that there was only one way to build. Just because LEGO has always done 6-wide steam trains with small wheels and angular boilers didn't mean that we couldn't try something new. I've never built trains before, so I tried to stay pretty open to challenging the limits of what this train could be.

The second role I had towards the AFOLs was to get them to try and build trains using the new Power Functions components. Since the Emerald Night was meant to be targeted at AFOLs, it was extremely important that the trains functionality did not compromise its aesthetic. We also wanted to see if they could come up with ways of building realistic steam trains without large wheels.

Was it helpful for you to have LEGO train fans that you could talk to about building Trains? Did anything end up in the final model from this input?

Definitely. Because of the work of the train fans, we became very aware of the need to finally release large train wheels. All of our attempts to use Racer's rims or Technic rims showed just how difficult it was to try and 'build' train wheels with existing elements. It really helped our case when requesting the new element from management. The idea of actually powering and driving the train through these new wheels offered a 'wow factor' that the team was looking for to help sell this new system as an evolution from previous ones.

The color choice for the train was also validated at the workshop. Additionally, we had a very healthy discussion about using stickers versus printing on elements. In the end, I think the Emerald Night is a good compromise.

I noticed that at the beginning of the workshop, you already had an image similar to the final train; did your interaction with the LEGO fans confirm this direction for you or did you consider a change?

We did try to do some brainstorming before the start of the workshop. It was important that the new train really stand out from styles we had done in the past—especially those trains created as exclusive offerings to adult fans like the Santa Fe and

The new Power Functions rechargeable battery box was the final result from the AFOL workshops. You can connect any combination of PF elements to the top plug. Also, an output could be set using the orange control. The size is 4 studs x 8 studs x 4 bricks.



The new PF RC Handset, with variable speed control, has Technic beams on the sides to allow you to attach more than one controller together to build your own controller.

Emerald Night: A Designer's Perspective

Article by Megan Rothrock
Art by the LEGO Group

BNSF. Steam trains seemed to be an obvious style to differentiate from the classic diesel and diesel-electrics we had done in the past. This helps explain why many of the references we brought to the workshop were indeed of a particularly iconic class of train.

That having been said, there were lots of amazing style suggestions brought by the fans. Some of the trains we chose not to do because they had too clean/modern an expression which was perhaps better suited for a train developed by the CITY team. Other trains were amazing, but perhaps not iconic enough for a global market. However a few really stood out as potential options for future trains in the range.

Several fans have noticed a similarity between the new LEGO big train wheels and those produced by the AFOL fan producer 'Big Bens Bricks', anything you would like to clarify?

The LEGO Group has had a full assortment of prototype train wheels dating well back to the 1970s and perhaps even sooner. The newly released large train wheel is just one of those wheels which finally had a reason for existence. Should we find a reason to do even bigger trains in the future, we know the wheels are already in the archives for scales far beyond mini-figure.

'Big Ben Bricks' has done an amazing job with his wheels. The LEGO wheels do offer a different experience in that they have extra spokes, counter-weights and allow you to add rubber bands. However, I still think Ben offers a great product in an impressive variety of colors.

Why is the train named the 'Emerald Night', were any other names considered?

The color of train is green, so we wrote all different words that were green. Then we looked up lots of names of famous trains and then tried to expand upon them. We originally liked Emerald Knight, but then took some artistic license by removing the 'K' to make it a bit more mysterious. 

A pile of the new flexible LEGO train track allows you to create your own train track layout curves.



“The Mighty Hood”



HMS Hood in LEGO Minifig Scale

Article and Photographs by Ed Diment

I am sure by now regular readers of *BrickJournal* will be familiar with the idea that I like to build big things! My most recently completed major project is the biggest yet and possibly just too big for a LEGO creation you might wish to have hanging around your home (at least I think my wife reckons this). I have no real idea why I build so big, but it probably has to do with enjoying building at Minifig scale, which dictates the size if the thing you are creating is big in the real world.

Since a young boy, aged no more than five or six, I have had an interest in ships, particularly naval vessels and have often tried to combine my two interests of Lego building with naval architecture. When younger, I tended to build much smaller ships, due to limitations on available bricks and brick types; alternatively, I would build civilian ships such as tankers, tugs and lifeboats. Only once I became an adult and had my own home did I attempt to build a minifig scale warship. My first few attempts could be considered ‘test-beds’, since the difficulties in constructing a ship of this scale needed ironing-out. The ultimate result of this process was *HMS Edinburgh*, presented in *BrickJournal* (Volume 1 issue 8).

HMS Edinburgh was never intended to be the ultimate conclusion of the minifig warship process. Whilst I was very pleased with the results achieved in building *HMS Edinburgh*, this only served to spur me on to create *HMS Hood*. She has always been my favourite warship, ‘a castle of steel’ as dreadnought battleships and battlecruisers have often been called. Whilst there are many famous and classic Battleship designs (the Iowa class, *Bismarck* and *Yamato* to name but a few) *Hood* was a one off, unique

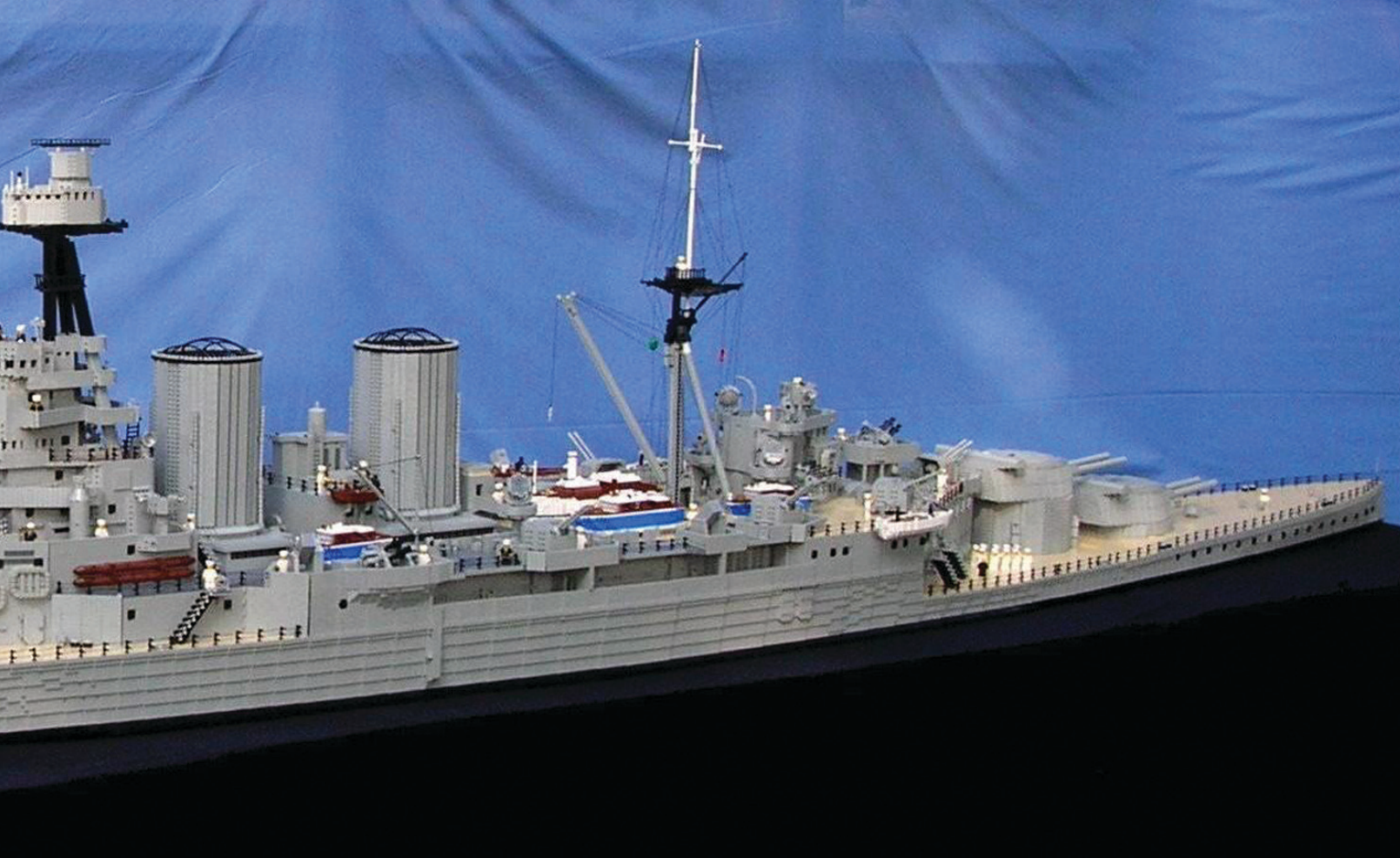

and extraordinary. The story of *HMS Hood* is also both fascinating and tragic, making her an excellent subject for a LEGO creation.

HMS Hood was the last of the battlecruisers, a class of ship conceived by British admiral John 'Jackie' Fisher, also the creator of the original *HMS Dreadnought*, forerunner of all 20th century battleships. The battlesruiser was intended to be as fast as a cruiser, but as heavily armed as a battleship, with the intention that they be able to hunt down and destroyer cruisers and armoured cruisers. In order to achieve this, however, armour had to be sacrificed. This was not generally a problem for the use for which these ships were intended, but became a fatal weakness if engaging dreadnoughts. This weakness was devastatingly revealed during the battle of Jutland, in 1916, when three British battlecruisers blew up after having their armour pierced by enemy shells.

HMS Hood was laid down on the same day as the Battle of Jutland. The results of the battle were soon realised and *Hood's* design was substantially altered, including the addition of an extra 7,000 tonnes of armour plate (this had the unfortunate side-effect of making the *Hood* a very wet ship). *HMS Hood* was launched in 1918 and commissioned in 1920, at which point she began a series of tours as the world's largest warship and the flagship of the Royal Navy. Over the next twenty years *Hood* visited dozens of countries worldwide, being seen by millions of people, and adopting the nickname: "The Mighty Hood". The ship also underwent a series of refits, the final one to bring her up to World War Two standards just before she sailed to intercept the German battleship *Bismarck*.



Top: A panoramic view of the HMS Hood.
Above: Looking at the aft guns.

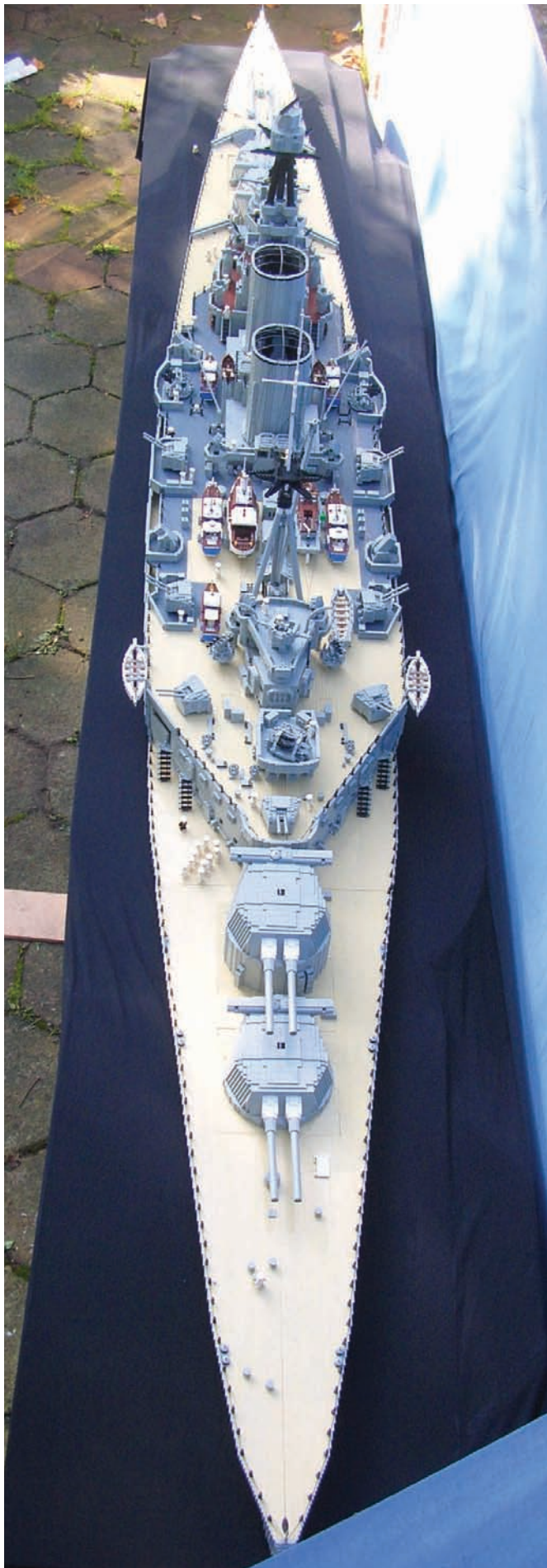

Creating *HMS Hood* in LEGO presented a vast array of challenges: could a model 20ft (6m) long and consisting of 100,000 bricks really be built; how many parts would it need to be in; how could it be transported and above all, would I have the time and money to do it? Having recently bought a large station-wagon, a few measurements told me I should be able to fit the MOC into the back, if the hull could be broken down into four sections, and enough of the masts, funnels etc. could be removable. Sourcing the bricks became the next issue, but fortunately a few things came together well in this regard. Firstly, I had all the LEGO elements available from dismantling *HMS Edinburgh*; secondly, a fellow club member was disposing of his supply of old grey in favour of new grey and finally, there was always Bricklink (an online LEGO part shop)!

Having worked out the practicalities and acquired the brick, the next stage was planning. I chose a scale of 1 to 43 for the ship, as this was a reasonable minifig scale compromise. I purchased a copy of a book called 'The anatomy of a ship' – specifically the *HMS Hood* copy. The series covers a range of vessels and gives detailed schematics and technical drawings covering every item of the ship, an invaluable resource. The next stage was to set-up a spreadsheet in order to calculate the scale of each individual element of the ship. This sheet contained hundreds of calculations giving height width and depth of every element on the ship. This sort of calculation is necessary when working on a creation of this scale, as failure to take into account relative size and location can result in severe distortion of the final model.

I decided early on that I would adopt the same technique for the hull construction and sides as used for *HMS Edinburgh*. This involves using stacks of bricks and plates sandwiched together with technic beams. Large numbers of technic lift arms are then pinned vertically to these, using the fact that two plates sandwiched between two beams allow a beam or lift arm to be pinned vertically. For a model of this size, with the largest section weighing 50lb (22kg), it is vital to build this sort of cross-pinned frame.

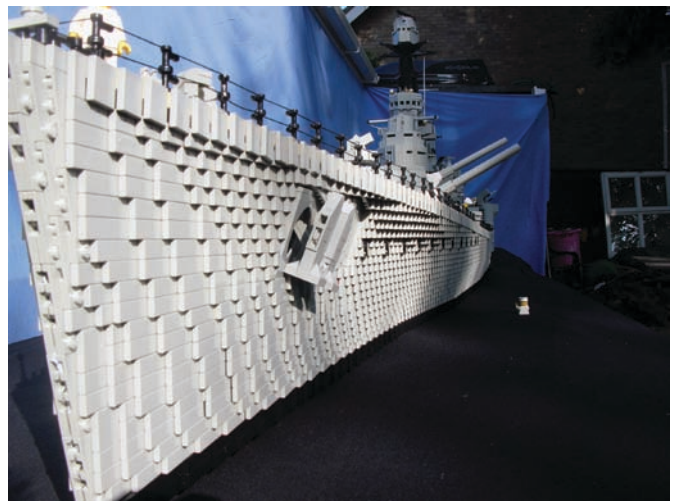

Left: A top view of the HMS Hood.
Above: A look at the plate detail on the hull.

The sides of the ship are plate mounted vertically and attached to bricks with studs on the side and right angled brackets. The hull is then clad in tile, using over 8,000 1x4 grey tiles.

Unlike *HMS Edinburgh*, however, I chose to construct the decks from bricks on their sides. This was in order to create a smooth deck and was possible as the top of the line of bricks on either side attached to the vertical plate of the hull sides. As with *HMS Edinburgh*, various parts of the ship are modular. This includes: the four main gun turrets; the funnels; the bridge structure; the main mast; the aft superstructure; the conning tower; the ship's boats and all the secondary armament.

I decided right at the start that I wished to use the new LEGO Power Functions system to drive the rotation of the gun turrets and elevation of the gun barrels. Since there are four channels and two controls on each channel it is possible to drive eight separate motors. Each turret has a large motor driving the rotation of the turret and a small motor driving the elevation of the gun barrels. The back of each turret can also be un-clipped in order to access the battery pack in each one. The infra-red receiver stands slightly proud of the top of each turret roof. The drive for both rotation and elevation is heavily geared down with worm gears and uses slip gears to prevent graunching the gears when the guns are at maximum or minimum elevation or rotation.

Some of the unusual construction techniques include the use of Bionicle rotation joints to hold the foremast legs at an angle, leaning in and forward, attached at either end. Two 8-wide arches are mounted connected base to base and angled outwards to form the anchor holes. The funnels and conning tower are constructed in two halves each from varying angles of slopes on their side in order to create curved surfaces.

The LEGO *HMS Hood* took seven months to build, working most evenings and weekends as well as a couple of weeks leave from work. There are a total of just under 100,000 bricks in *HMS Hood*, she is just under 20ft (6m) long and 3ft (1m) wide and weighs in at about 200lbs (90kg).

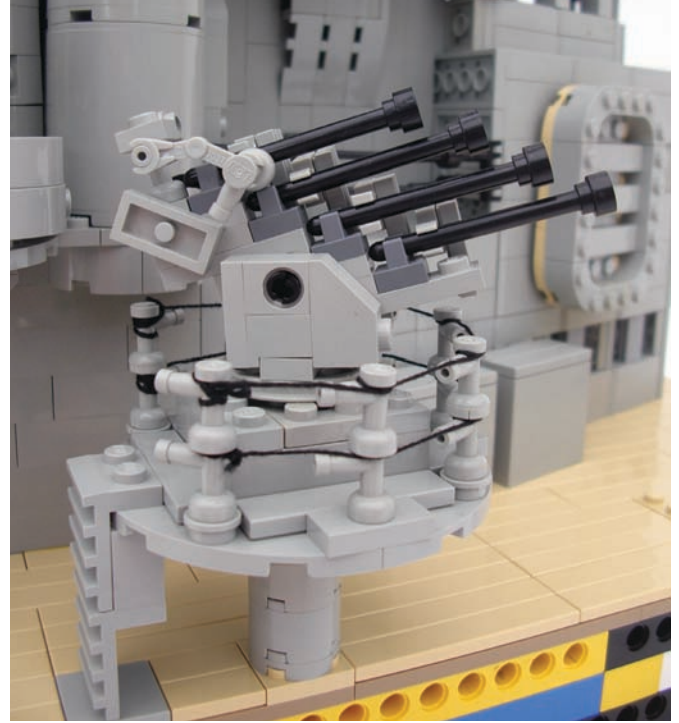

Left: A model of the pom-pom guns onboard the ship.
Top: Anti-aircraft guns mounted on deck.
Above: A look at the supestructure.



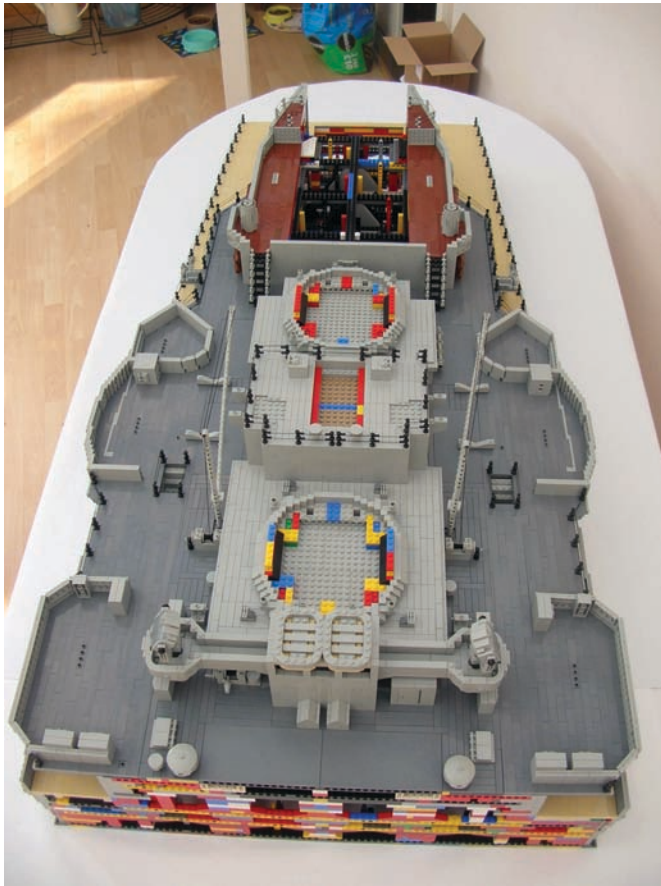

The real *HMS Hood* was sent to patrol the Denmark Strait with the newly commissioned battleship *Prince of Wales* in May 1941. Their task was to intercept and attack the German battleship *Bismarck* and her cruiser escort *Prinz Eugen*. On the morning of 24th May *Bismarck* was sighted and *Hood* and *Prince of Wales* steered an intercept course, opening fire first. Return fire from the German ships came quickly and accurately with an early shot from *Prinz Eugen* starting a fire on *Hood's* boat deck. Moments later a shell from *Bismarck* was thought to have penetrated the aft end of *Hood's* boat deck and caused an explosion in her torpedo magazines. The subsequent flash detonation of *Hood's* main magazines caused a catastrophic explosion that tore the ship in two. *HMS Hood* sank in less than three minutes taking all but three of her crew of 1,417 with her. Subsequent to the sinking of the *Hood* a huge search and destroy operation was launched by the Royal Navy and three days later the *Bismarck* was sunk in the Atlantic, West of France.

This MOC is dedicated to the brave officers and crew of the *HMS Hood* who were lost in such tragic circumstances. 

For many pictures of this model, please go to:
<http://www.flickr.com/photos/legomonster/>

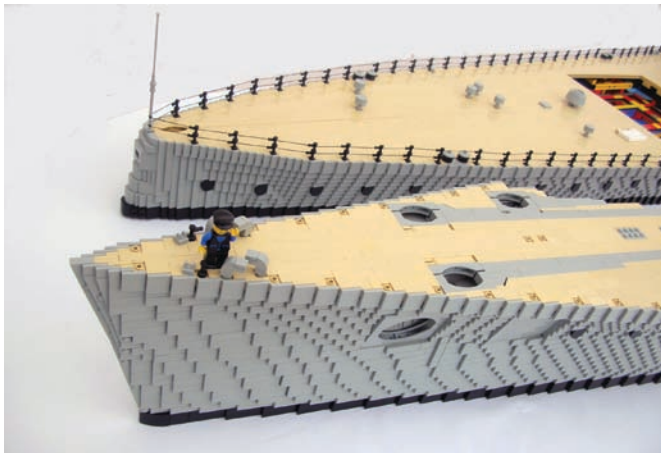

Top left: Section 2 (midship) ready for transport.
 Middle left: Stern (top) and bow ready for transport. Section 1 is the bow, section 3 is the stern.
 Bottom left: A look inside the superstructure of Section 2.
 Below: Section 3 (stern section) completed.

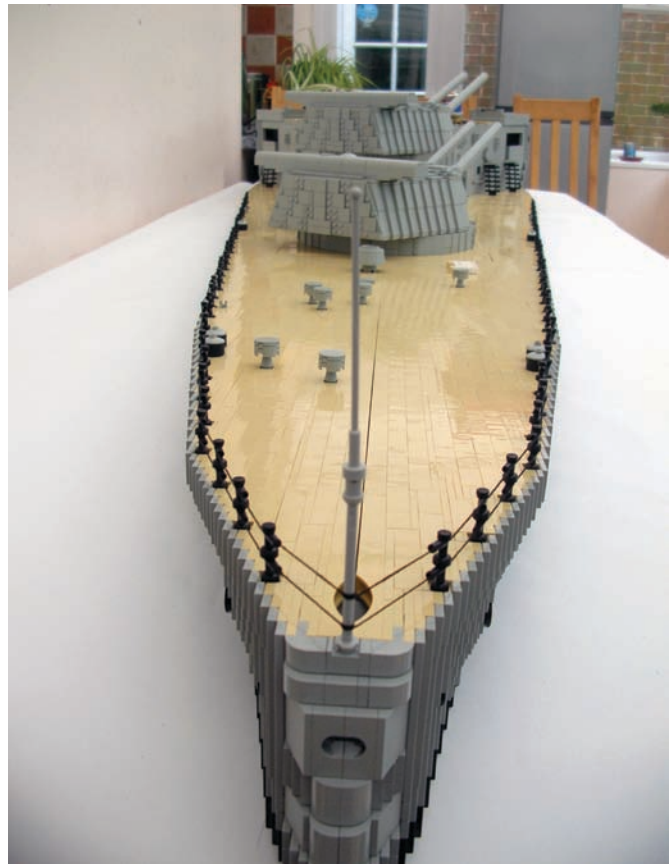
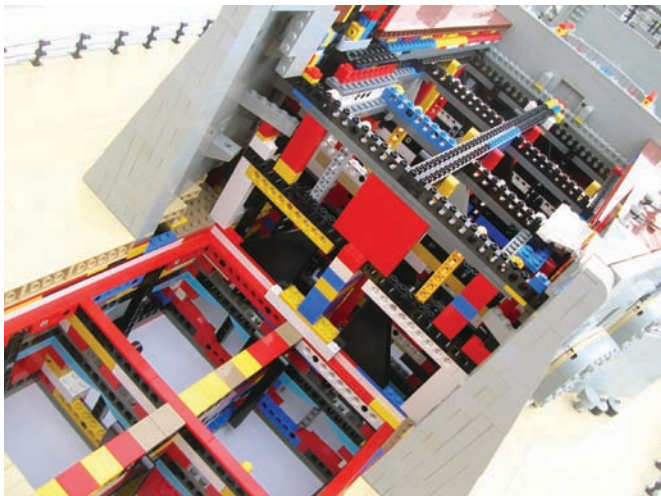

Casting Parts in Resin Plastics

*Article and Photography
by Jared Burks*

Welcome back to the Minifig Customization Series. This installment is packed with details on casting in resin plastics. Now that everyone has had time to practice making a silicon rubber mold we can address the concept of resin plastics. Recall the articles on creating custom elements in clay (V. 2, I. 1), element modifications (V. 1, I. 7), and silicon rubber molding (V4); with the information in these articles and the information below you will be able to create, mold, and cast a custom element in durable resin plastic. As you will be using chemicals in not only the creation of these custom elements but also in the molding and casting stages please READ all safety information for all the products you use. The creation and use of resin plastic by younger readers will require adult supervision.

Resin Characteristics

Resin plastics are composed of two parts much like the silicon rubber. By mixing part A with part B an exothermic (heat generating) chemical reaction takes place curing the resin into a hard plastic. Most resins are a 1:1 mixing, however a few are not, so read the instructions carefully for the resin you choose. I recommend the 1:1 mix for easy of use. Resin has a pot life, demold time, viscosity, tensile strength, and hardness, much like silicon rubber. These characteristics effect how long the resin will take to cure, how well it will flow in the mold, and how strong the final part will be.

Resins typically have a much shorter pot life and demold time than silicon rubbers. Because of this shorten duration resin must be quickly mixed and poured into a mold before it cure. If mixing takes too long the resin will start to cure and thicken keeping it from being pourable and thus it won't enter the mold. Most resins are referred to as water thin; this is in reference to their viscosity. A low viscosity resin will pour very easily. This means the resin will more easily fill small voids in the mold. Tensile strength and hardness refer to the strength of properly mixed resin plastic. If the resin is improperly mixed or it contains bubbles the strength will suffer. The hardness also indicates how durable your final part will be; keep this in mind if you intend to sand the final product or if it is intended for rough play.

I prefer resins with 3-5 minute pot lives, anything shorter is hard to properly mix and get into the mold. And as with silicon be sure to mix thoroughly; this means mix in one cup and then transfer to a new cup to continue mixing. My rule of thumb for mixing is one-third of the duration of the pot life. This gives you the other two-thirds of the pot life to pour the resin into the mold. Mix gently, but thoroughly to avoid excess bubble formation. Also note, improper mixing can also affect the cured resin color.

Coloring Resin

Most resins will turn white when cured, however there are some that turn, amber, clear, tan, opaque, and yellow. If you intend to color your resin you need to keep this characteristic in mind as it will affect the colors you can achieve. For example it is very difficult to achieve black colored resin when using white cure resin. When mixing the black pigments with the white



Figure 1: Pigments

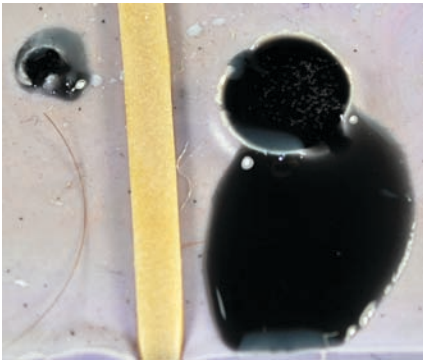

Figures 2 & 3: Examples of mild foaming.



cure resin the resin will turn light or dark grey depending on how much black pigment is added. One would have to use a clear or amber cure colored resin. White resins typically have a higher shine and greater strength, so I prefer to work with them. It is possible to work around the color issue mentioned above for most colors; however you must be careful of foaming.



Figure 4: Foaming on a resin part.

When you mix too much pigment into a resin plastic you are adjusting the water

content and plastic to hardener ratio of the resin. Most pigments are suspended in either water or oil. When adding a pigment this added liquid volume can affect many of its properties, most importantly the foam point. When a resin contains too much moisture (from pigments or humidity) it will foam creating hundreds of bubbles in the resin as it cures. The exothermic (heating) reaction causes these bubbles to form, which will ruin the part. Use a small amount of resin and pigment to test the color you wish to make prior to pouring several parts or mixing large batches of colored resin. Start slowly and test the foaming point. Also test the demold time of the resin, as you add more pigment you will need to extend the duration you leave it in the mold.

Typically most companies offer pigments in the following colors; white, black, red, blue, yellow, green, and brown (primary and secondary colors). These colors must be mixed together to achieve the color you desire. Creating custom color recipes will take quite a bit of time, so make sure to take notes. This does not mean you will have perfect color matching or consistency. Day to day humidity changes and mixing variability will affect the final color.

Some pigments are available in a powder form, which is great from a foaming stand point, but this makes them much more difficult to use. Measuring powders to determine the quantity to add to resin is difficult. Also powders have an ability to find their way into places they shouldn't. Remember these are VERY concentrated pigments so very little on your floor, clothes, or hands could result in a massive mess. If you choose to go this route be very careful and get a VERY accurate scale.

Filling the Mold

One would think that filling the mold would be easy. However there is a process that will extend the life of the mold and aid in casting. As previously mentioned when the resin parts are mixed together an exothermic reaction occurs. This will ultimately destroy the mold so take every precaution to protect and extend the life of the mold with each casting. First, the mold should be sprayed with mold release, I prefer Mann's Ease Release 200. This will help keep the silicon rubber from drying out due to the heat and thus extend the life of the mold. This will also keep the mold from sticking to the resin once cured. Spray the mold with a thin even coat before each use and then with a dry paint brush to gently brush over the mold to make sure every surface is evenly covered. Allow the mold to sit for 3-5 minutes for the release agent to dry. After casting it is also best to let the mold rest and cool, the silicon will hold heat for some time and it is this heat over time that will destroy the mold. Immediate repeated castings can expedite the mold failure.

Once your release agent is dry you have to determine how you are going to fill your mold. Many people employ the same thin stream method used when pouring the silicon. This will minimize bubble formation in the resin; however I prefer to use a plastic pipette. These are small plastic graduated tubes with a squeeze bulb on one end. This allows the user to uniformly push the resin into the mold. I find that this pressure helps to fill the mold very uniformly, if the mold is properly designed. This also avoids the mess of the thin stream pour and speeds the resin into the mold while still water thin. However, because this is not a thin stream pouring we risk the addition of bubbles. This means we have to employ other techniques to remove or minimize the risk of bubbles.

Bubbles can be minimized by several methods including; taping, vibration tables, extra fill volume, brushing the mold with resin, and new air/overflow tubes. Taping



Figure 5: Mold Release.

is the simplest method to attempt to remove air from the mold, merely tap the mold on a solid surface in an attempt to drive any air bubbles up and into the air / overflow vents in the mold. This method can be stepped up by using a small vibrating massager. Merely touch the vibrating massager to the bottom of the mold and let the vibrations free the trapped air. Be careful both of these methods can splash resin out of the mold.



Figure 6: Pipettes.

Another method for eliminating air bubbles is to use a paint brush and brush or pour some resin into trouble spots to ensure air cannot be trapped in these regions when the mold parts are assembled. This is particularly useful for small regions at the bottom of the mold. Be careful when using this method; keep an eye on the pot life of your resin. It may take longer to fill these areas, assemble the mold, and fill the main mold void before the resin cures.

All resin volumes slightly shrink when curing. This means if you completely fill the mold when you take it apart the resin will have pulled back into the mold slightly. If the air / overflow tubes are short, this shrinkage could pull air into your mold. This issue can be counteracted with the addition of some small straws or reservoirs in the air / overflow areas. The added weight and volume of extra resin will keep air out of the mold and fill it as the resin shrinks during curing. This issue can be avoided with proper mold creation.

When filling your molds you might be confronted with a continual air trapping issue. This could be resolved by cutting a new air / overflow vent in your mold. This can be done with an X-acto knife; however I recommend a rotary tool with either a cutter or drill bit attached. Cut through the rubber mold slow, especially if it is a very elastic mold. This is one way to salvage a mold and make it functional. If you mess up and need to repair the mold remember that rubber will stick to rubber unless mold release is used. So you could fix any error by pouring new rubber into the error. Just remember you will need to fill the internal volume and any air / overflow tubes you wish to keep and also coat these areas with mold release.

The final way to avoid air bubbles is to understand why they form in the first place. Yes it can be simply trapped air because of small areas, but they can also form in other areas for no apparent reasons. Most commonly they form in these areas because of surface imperfections in the custom part. These small imperfections allow a place for the bubble to form or rest. Through the use of better part sanding technique before the mold is created these areas can be minimized and removed as a source of air bubble formation. So spend the extra time to completely sand the parts you wish to mold and cast.

Wrap-up

Now that you have the secrets to basic molding and casting let's see what you can create. Be sure to reread all the articles as each will give small insights that can improve your work. This is a process and by cheating at any step you will sacrifice the results of the next. Enjoy making your own plastic parts. **b**

Next Time:

Minifig Customization 101 – Advanced Parts Modification

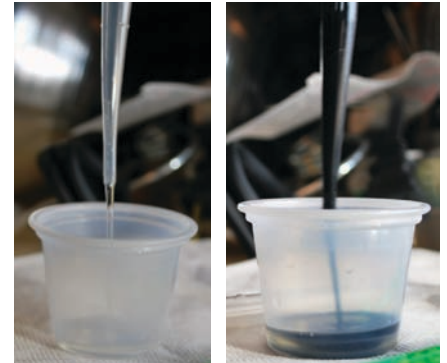

Figure 7 & 8: Using a pipette for resin.

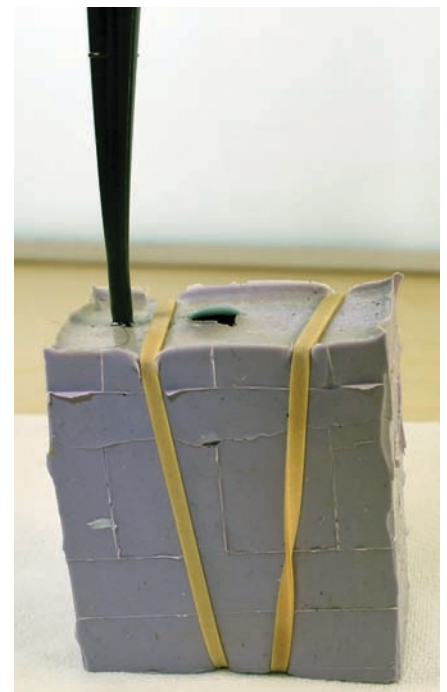

Figure 9: Using a pipette for adding resin in a mold.

Miniland Building

The Toddler

Article, Photography
and Art by Didier Enjary



The model we are going to build today is quite small, but that does not mean simple. It is an infant on white diaper, toddling on the floor and playing with a red ball. We have to consider the original design as three separated modules.

1. The head is an obvious build, however you can refer to previous *BrickJournal* issues for clarification. It is placed on a jumper plate linking two 1x1 technic bricks and pins: the shoulders and torso.

2. The body is a stack of white plates, figuring the diaper.

3. The legs consist of two bricks with curved top linked with a 1x2 white tile and plates modified with clip for the feet. These latter parts are rare in tan (flesh) color and I recommend you to use the 1x1 plate modified with tooth instead.

1a

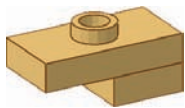

1b



1c

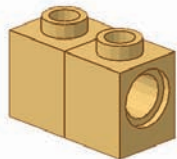

1d

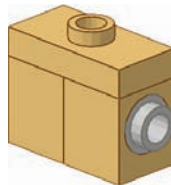

2

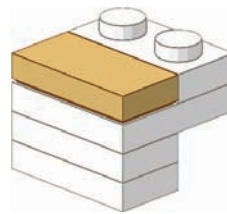

3

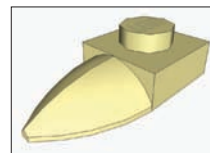
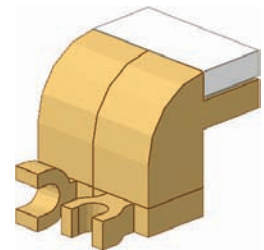

1x1 plate modified with
tooth, in tan.

You are almost finished now. First, place the legs upside down (4a). They don't stand up correctly by themselves until you place the body (4b). Add the torso and head - the two arms (1x2 tiles) are connected to the shoulders-pins making the whole thing stable. Finally, a 1x1 round plate represents a red ball. The toddler is ready to play with the puppy!

4a

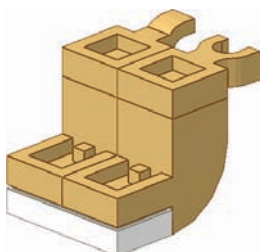

4b

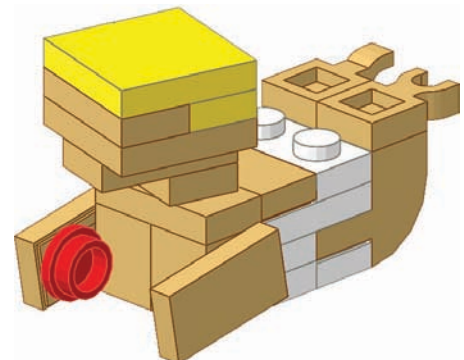
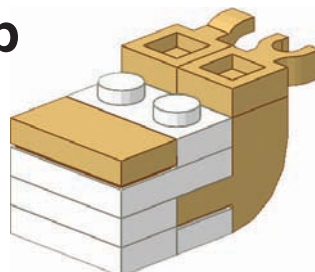

NEW BOOKS & MAGS FROM TWOMORROWS!



BACK ISSUE #35

"Villains!" **MIKE ZECK** and **J.M. DeMATTEIS** discuss "Kraven's Last Hunt" in a "Pro2Pro" interview, the history of the Hobgoblin is exposed, the Joker's short-lived series, looks back at Secret Society of Super-Villains and Kobra, a Magne-to biography, Luthor and Brainiac's malevolent makeovers, interview with Secret Society artist **MIKE VOSBURG**, plus contributions from **BYRNE, CONWAY, FRENZ, NOVICK, ROMITA JR., STERN, WOLFMAN**, and a cover by **MIKE ZECK!**

(100-page magazine) \$6.95 US
Now shipping!



DRAW! #18

Features an in-depth interview and demo by **R.M. GUERA** (the artist of Vertigo's Scapled), behind-the-scenes in the Batcave with Cartoon Network's **JAMES TUCKER** on the new hit show "Batman: The Brave and the Bold," plus product reviews by **JAMAR NICHOLAS**, and Comic Book Boot Camp's "Anatomy: Part 2" by **BRET BLEVINS** and **MIKE MANLEY!**

(80-page magazine with COLOR)
\$6.95 US

Ships August 2009



KIRBY COLLECTOR #53

Spotlights **THE MAGIC OF STAN & JACK!** There's a new interview with **STAN LEE**, a walking tour of New York showing where Lee & Kirby lived and worked, a re-evaluation of the "Lost" **FF #108** story (including a missing page that just surfaced), "What If Jack Hadn't Left Marvel In 1970?" plus **MARK EVANIER's** regular column, a Kirby pencil art gallery, a complete Golden Age Kirby story, and more, behind a color Kirby cover inked by **GEORGE PEREZ!**

(84-page tabloid magazine) \$9.95 US
Ships July 2009



ALTER EGO #87

The sensational 1954-1963 saga of Great Britain's **MARVELMAN** (decades before he metamorphosed into Miracleman), plus an interview with writer/artist/co-creator **MICK ANGLIO**, and rare Marvelman/Miracleman work by **ALAN DAVIS, ALAN MOORE**, a new **RICK VEITCH** cover, plus **FRANK BOLLE, Part 2, FAWCETT COLLECTORS OF AMERICA, MR. MONSTER**, and more!

(100-page magazine) \$6.95 US
Now shipping!

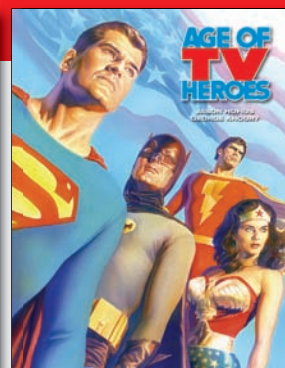

AGE OF TV HEROES

Examines the history of the live-action TV adventures of everyone's favorite comic book heroes! Features new and exclusive interviews and commentary from **ADAM WEST** (Batman), **LYNDA CARTER** (Wonder Woman), **PATRICK WARBURTON** (The Tick), **NICHOLAS HAMMOND** (Spider-Man), **WILLIAM KATT** (Greatest American Hero), **JOHN WESLEY SHIPP** (Flash), **JACKSON BOSTWICK** (Shazam!), & more!

(192-page FULL-COLOR HARDCOVER)
\$39.95 US • ISBN: 9781605490106
Ships August 2009



ALL-STAR COMPANION Vol. 4

Features: Colossal coverage of the Golden Age **ALL-STAR COMICS!** Sensational secrets of the **JUNIOR JUSTICE SOCIETY!** An index of the complete solo adventures of all 18 original JSAers in their own features, from 1940 to 1951! The JSA's earliest imitators (Seven Soldiers of Victory, All Winners Squad, Marvel Family, and Intl. Crime Patrol)! **INFINITY, INC.** on Earth-Two and after! And the 1980s **SECRET ORIGINS** series! With rare art by **ALEX ROSS, TODD McFARLANE, JERRY ORDWAY, CARMINE INFANTINO, JOE KUBERT, ALEX TOTI, GIL KANE, MURPHY ANDERSON, IRWIN HASEN, MORT MESKIN, GENE COLAN, WAYNE BORING, GEORGE TUSKA, MICHAEL T. GILBERT, GEORGE FREEMAN, DON NEWTON, JACK BURNLEY, MIKE MACHLAN, HOWARD CHAYKIN, DICK DILLIN**, and others. Edited by **ROY THOMAS**.

(240-page trade paperback) \$27.95 US
ISBN: 9781605490045
Diamond Order Code: APR091002
Now shipping!



COMIC BOOK PODCAST COMPANION

Comic book podcasts have taken the Internet by storm, so go behind the scenes of ten of today's top comic book podcasts via all-new interviews with the casts of **AROUND COMICS, WORD BALLOON, QUIET! PANELOGISTS AT WORK, COMIC BOOK QUEERS, IFANBOY, THE CRANKCAST, THE COLLECTED COMICS LIBRARY, THE PIPELINE PODCAST, COMIC GEEK SPEAK, and TwoMorrrows' own TUNE-IN PODCAST!** Also featured are new interviews about podcasting and comics on the Internet with creators **MATT FRACTION, TIM SEELEY, and GENE COLAN**. You'll also find a handy guide of what you'll need to start your own podcast, an index of more than thirty great comic book podcasts, numerous photos of your favorite podcasters, and original art from **COLAN, SEELEY, DC's MIKE NORTON**, and many more! By **ERIC HOUSTON**, with a spectacular new cover by **MIKE MANLEY**.

(128-page trade paperback) \$15.95
Diamond Order Code: MAR094433
ISBN: 9781605490182 • Now shipping!



MARVEL COMICS IN THE 1960s

This issue-by-issue field guide presents a step-by-step look at how Marvel Comics went from being one of the least creative publishers in a generally moribund industry, to its most dynamic and original in an era when pop-culture emerged as the dominant force in the artistic life of America. In scores of handy, easy to reference entries, follow the company's first fumbling beginnings as helmed by savvy editor/writer **STAN LEE** (aided by such artists as **JACK KIRBY** and **STEVE DITKO**), to the full maturity of its wild, colorful, offbeat grandiosity. With the history of Marvel Comics in the 1960s divided into four distinct phases, author **PIERRE COMTOIS** explains just how Lee, Kirby, Ditko, and others created a line of comic books that, while grounded in the traditional elements of panel-to-panel storytelling, broke through the juvenile mind-set of a low brow industry and provided a tapestry of full blown pop culture icons.

(224-page trade paperback) \$27.95 US
Diamond Order Code: MAY091042
ISBN: 9781605490168 • Ships July 2009



CAPTAIN ACTION: THE ORIGINAL SUPER-HERO ACTION FIGURE

REVISED 2nd EDITION! CAPTAIN ACTION was introduced in 1966 in the wake of the Batman TV show craze, and later received his own DC comic book with art by **WALLY WOOD** and **GIL KANE**. Able to assume the identities of 13 famous super-heroes, continuing interest in the hero has led to two different returns to toy-store shelves. Lavishly illustrated with over 200 top photos, this **FULL-COLOR HARDCOVER SECOND EDITION** chronicles the history of this quick-changing champion, including photos of virtually **EVERY CAPTAIN ACTION PRODUCT** ever released, spotlights on his allies **ACTION BOY** and the **SUPER QUEENS** and his arch enemy **DR. EVIL**, an examination of his comic-book appearances, and more, including his recent return to comics shelves and the new wave of Captain Action collectibles. By **MICHAEL EURY**.

(176-page FULL-COLOR HARDCOVER)
\$39.95 US • ISBN: 9781605490175 •
Diamond Order Code: APR091003
Ships July 2009



VOLUME 21: CHRIS SPROUSE

(128-page trade paperback) \$14.95 US
ISBN: 9780160549017
Diamond Order Code: NOV084298
Now shipping!

VOLUME 22: MARK BUCKINGHAM

(128-page trade paperback) \$14.95
ISBN: 9781605490144
Diamond Order Code: FEB094473
Ships July 2009

Each features an extensive, career-spanning interview lavishly illustrated with rare art from the artist's files, plus huge sketchbook section, including unseen and unused art!

Go to www.twomorrrows.com for **FULL-COLOR** downloadable PDF versions of our magazines for only **\$2.95-3.95!** Print subscribers get the digital edition **FREE**, weeks before it hits stores!

2009 SUBSCRIPTION RATES: (with FREE Digital Editions)	Media Mail	1st Class US	Canada	1st Class Intl.	Priority Intl.	Digital Only
JACK KIRBY COLLECTOR (4 issues)	\$50	\$60	\$60	\$84	\$136	\$15.80
BACK ISSUE! (6 issues)	\$44	\$60	\$70	\$105	\$115	\$17.70
DRAW! (4 issues)	\$30	\$40	\$47	\$70	\$77	\$15.80
ALTER EGO (12 issues) Six-issues is half-price!	\$88	\$120	\$140	\$210	\$230	\$35.40
BRICKJOURNAL (4 issues)	\$38	\$48	\$55	\$78	\$85	\$15.80



For the latest news from TwoMorrrows Publishing, log on to www.twomorrrows.com/tnt



TwoMorrrows. Celebrating The Art & History Of Comics.

TwoMorrrows • 10407 Bedfordtown Drive • Raleigh, NC 27614 USA • 919-449-0344 • FAX: 919-449-0327 • E-mail: twomorrow@aol.com • www.twomorrrows.com



Got SNOT? It's not what you may think...

(Part 2 of an ongoing series)

Article and Photography
by Scott Lyttle

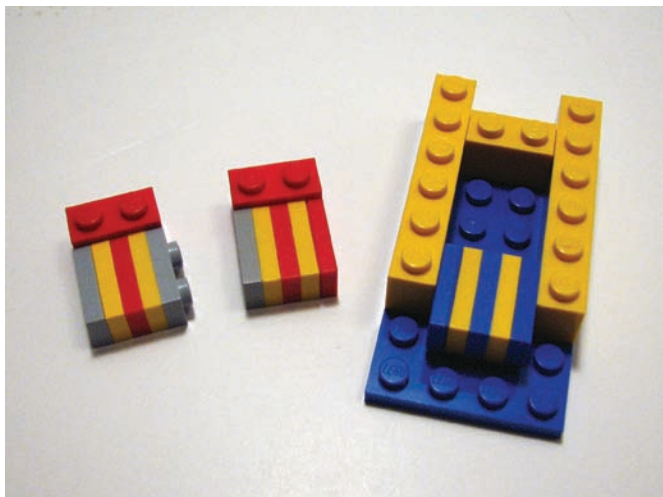

Figure 1: Basic 2:5 SNOT – 5 plates sideways = two upright studs

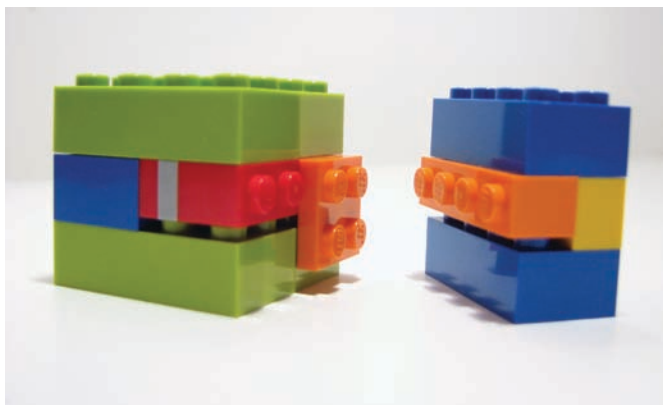

Figure 2: Height of a stud is $\frac{1}{2}$ plate, very handy when one sideways brick is $2\frac{1}{2}$ plates high.

In part 1 (BrickJournal issue 5), the “2:5” rule was explained as the key to SNOT techniques, using bricks, plates and tiles. Two LEGO upright studs equals five LEGO plates (or more specifically, 4 plates and 1 tile) turned sideways (See Figure 1). However, what about SNOT for under two studs?

Dividing the “2:5 rule” in half, you get the “1: $2\frac{1}{2}$ rule”, defined as each upright stud equals a width of $2\frac{1}{2}$ plates. A half-plate? LEGO doesn’t make a half-plate! How are you supposed to work with half a plate? Half thickness plate sizes do exist in LEGO bricks, you just have to know where to find them. In part 1, the fifth plate had to be replaced with a tile, because the studs of the fifth plate made the stack too wide (Figure 1). If you look carefully, the extra space made up by the studs on top of the fifth plate—is a half-plate!

Take a LEGO plate, look at it sideways. Notice there are two parts to it: 1) The square “flat” part of the element, and 2) The round studs. The square part is one plate thick—and the height of the studs, as it turns out, are a half plate. So, doing a little figuring here:

- The width of a sideways single stud brick works out to $2\frac{1}{2}$ plates high.
- The height difference of a stud is $\frac{1}{2}$ plate high.
- The height of an upright LEGO brick is 3 plates.

Putting it together, $2\frac{1}{2} + \frac{1}{2} = 3$. Time to try an exercise. Take (2) 2x4 bricks, and (2) 1x4 bricks. Place a 1x4 brick on top of a 2x4 brick. Then lay the other 1x4 brick sideways on top of the 2x4 brick. Then, place the second 2x4 brick on top. (Figure 2). Surprise! You just figured out how to make a half plate work! Looking at the 1x4 sideways brick, it does “jut out”, but how far does it stick out? Use your SNOT 2:5 and SNOT 1:2 $\frac{1}{2}$, and you can figure the “jut out” part would be $\frac{1}{2}$ plate. If you increase the depth to two studs, you get five plates of depth, with only the studs sticking out and being flush with the sides of the brick (Figure 2). This can be used for architectural details, like trim and cornices. More on that in a later issue.

A great application of SNOT is making your own roads. Roads are a great way to get familiar with the 2:5 rule. There are two techniques to make SNOT roads: a) the 2-stud brick method, and b) the 1-stud brick method.

The 2-stud brick method : Take a black brick, 2 studs wide. Turn the brick sideways so the studs are facing out. Applying 2:5 rule, the brick is five plates high. Because two (studs-up) bricks are 6 plates high, you are missing a plate. This is fixed by adding a tile under the road as a support. Your overall construct will be 6 plates (or two bricks high) (Figure 3). You can then use larger plates or bricks to build out over the edge of your road. The advantages of this technique are that you can use both 1-stud and 2-stud wide bricks, which is effective if you have limited quantity of black. The disadvantage is that you have to lift your entire base up by 2 bricks, so if you have any odd colors, using them as filler bricks are a good idea.

The 1-stud brick method: Take a black brick, 1 stud wide. Lay down the brick sideways directly on top of the baseplate. As seen in Figure 2, the height of the 1-stud wide brick and the $\frac{1}{2}$ plate height of a stud add up to 3 plates, or 1 brick, high. The advantage of this is that your build is only 1 brick high, making your road construct a little lower. The disadvantage of this is being limited to 1-stud thick bricks, and due to thickness, the road will be weaker.

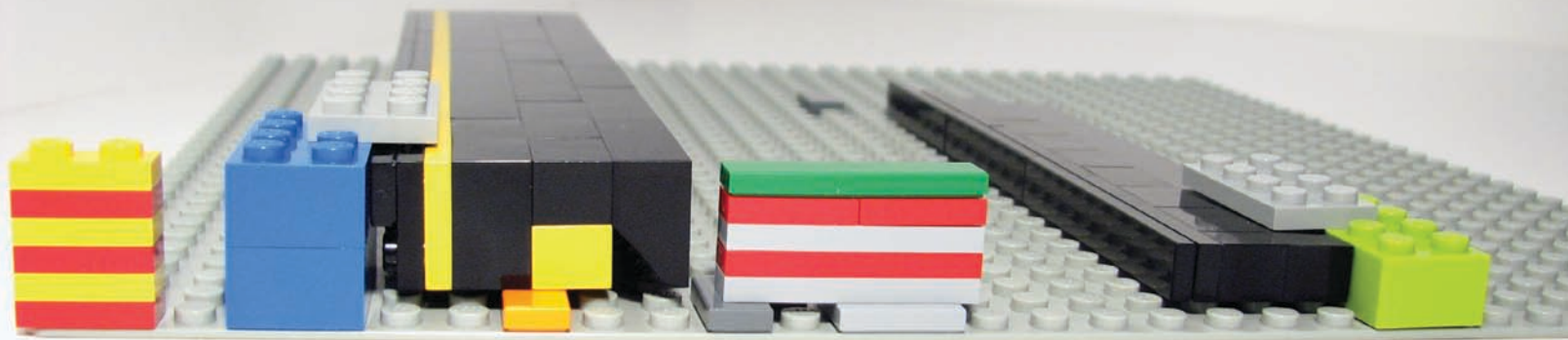



Figure 3: SNOT techniques, showing 2-brick and 1-brick SNOT road technique.

Now that you have your road technique in place, you can “build in” features into your road: cross walks, manhole covers, even signage in the road is possible! (Figure 4)

Imagine doing the same thing, but making one solid neutral color (like gray or tan). You can make that into the roof of a building. Many larger buildings have flat rooftops. Just keep to the 2:5 rule, and you should have it. See if you can try to make one yourself, and even try to build in details like rooftop air conditioners! (Figure 5).

Would you like to fill in for Scott, showing off your use of SNOT techniques? Drop Scott an e-mail to scott@brickjournal.com, he’s always looking for great use of SNOT! 

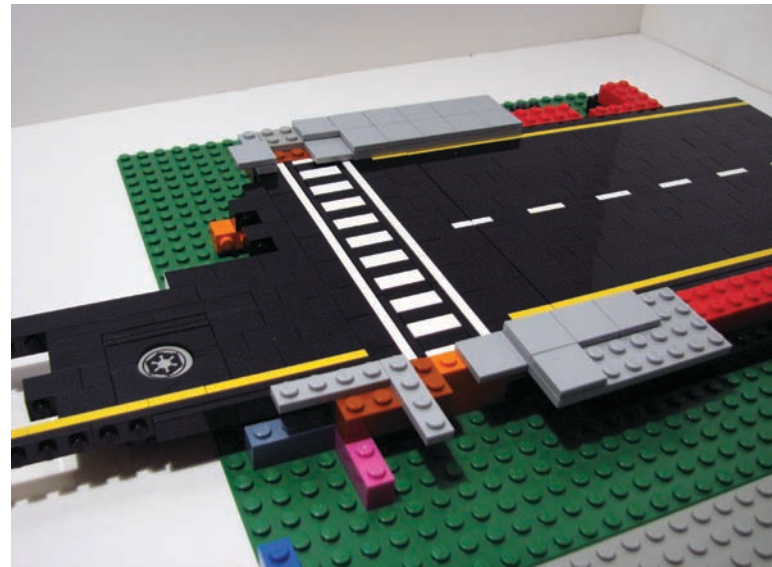
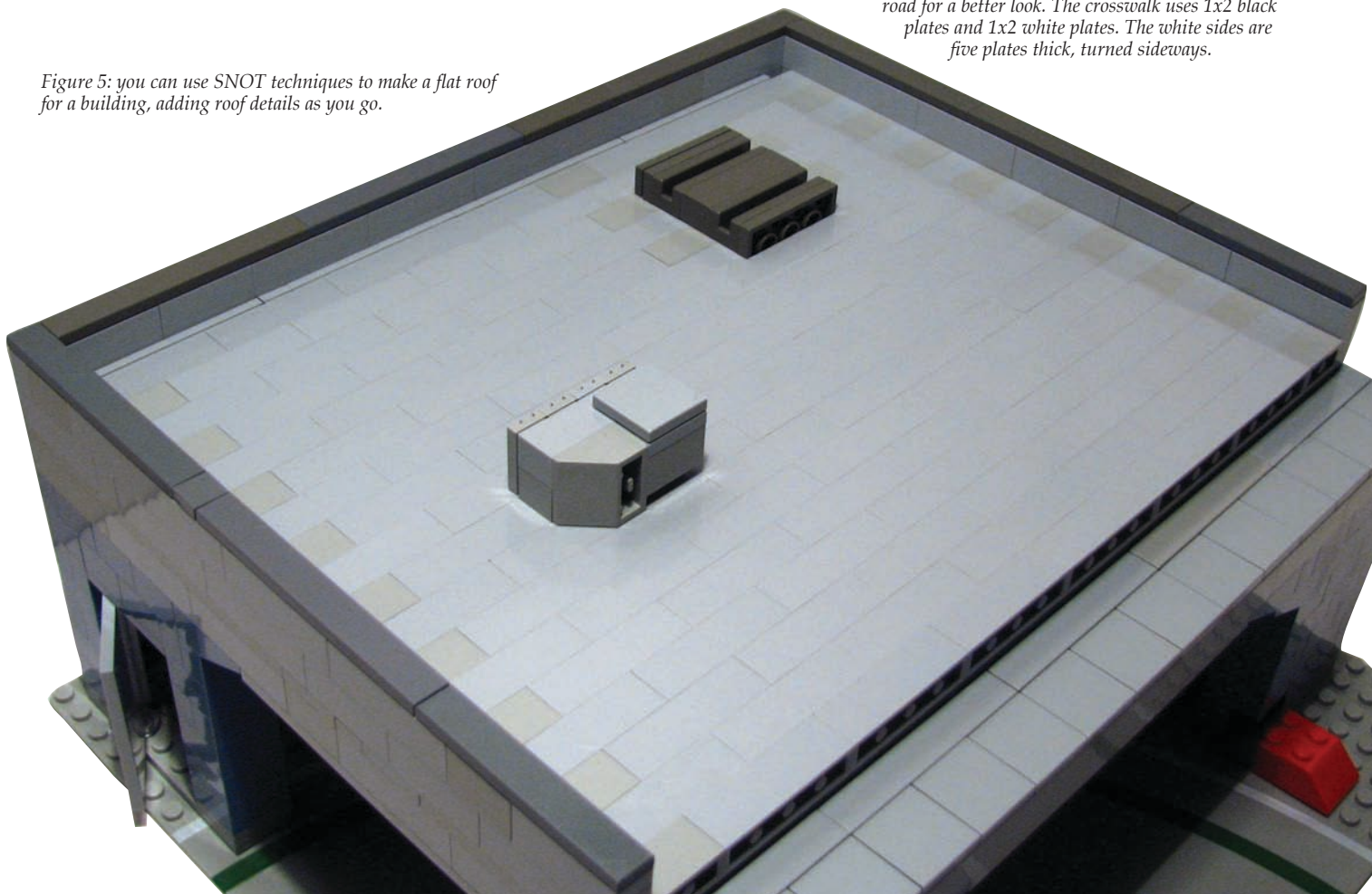

Figure 4: SNOT road details can be built into the road for a better look. The crosswalk uses 1x2 black plates and 1x2 white plates. The white sides are five plates thick, turned sideways.

Figure 5: you can use SNOT techniques to make a flat roof for a building, adding roof details as you go.



Community

Confessions of a BrickFest® Virgin

*Article by Jennifer Wagner
Photography by John Langrish,
Chris Wunz, and Bill Ward*



BRICKFEST 2009, held in Portland, Oregon March 27-29 2009 was jointly organized this year by Steve Barile and Christina Hitchcock; both seasoned AFOL convention pioneers. In all there were over 230 registered fans set to attend and displays encompassing over 30,000 square feet. The LEGO group was well represented, including keynote speaker Tormod Askildsen, the head of Community Development at Lego, Billund. I consider myself fortunate to have finally been able to attend a real “fest”.

It was with no small amount of trepidation that I entered the convention hall for the first time. I had arrived with the greatest haste my meager travel budget could afford and still only managed to get there near the end of the first day of the event. I was crushed, as I felt I had already missed so much of this eagerly anticipated weekend. I also had arrived for the very first time at an AFOL event completely alone. My usual entourage of husband and kids were not with me and their absence was keenly felt as I slunk late into the event hall. I hoped that I would find a few people to talk to so that I would not spend the next three days alone admiring the inspiring work of others. You see, despite my best intentions and this being my 4th AFOL event, I had arrived yet again, empty handed with no completed MOC to display. I was pretty disappointed in myself as I had really wanted to showcase my work alongside the work of all the other builders there. My fears, however, were completely groundless as I was welcomed immediately and found plenty of people willing to listen to me babble on excitedly about everything in sight!

Soon enough, the power of the assembled MOCs had me locked in a tractor beam being drawn toward the nearby display tables. One of the first creations that drew me in was that of Dan Parker’s incredible blue and grey curved rail roofed building. I must confess I could not help myself...I stroked the top of it in admiration completely forgetting that touching the models is considered bad form. In my defence, I maintain that this building truly invited the urge to touch as it has such an intriguing smooth yet textural effect. Moving around the room I happily devoured the sights of display after display; heartily ingesting each one. Another stand out for me was the incredible and massive Best of Castle winning tree made by Thomas Rafert. It loomed so realistically over the field of tiny sheep and battle figures below. I was lucky to be able to watch it grow from its makers hands as he assembled it from a most impressive collection of rare brown slopes.

Trains trains trains....this event was loaded with incredible trains! And there was even a special treat in store for us later at the opening ceremonies. We were given a rare peek inside the development and assembly of the newly released set #10194 Emerald Night Train with its brand spanking new Power Functions controls and slick LED lights. (Not to mention the new Flex track system just begging for use in new and dynamic ways thanks to its multi directional curve capabilities.) The Night Train is a sleek dark green steam locomotive with gold accents and features brand new piston powered wheels directly modelled after those designed by Big Ben Bricks. These prized multi-sized wheels have been desired by trainheads for many years and now LEGO has finally heeded their call.

Steve Barile also did much to add innovation to this year’s event. For me, the most appealing addition was that of a

new program called BrickKids. It's a mini 'convention within the convention' just for Teenage Fans of LEGO (TFOLs) aged 10-15 years. Registered youths were given a private guided tour of all the displays as well as time with a real LEGO designer! The session was run by Mary Plumridge and Kelly McKiernan and completely sold out in advance online. Feedback from these builders of tomorrow was extremely positive and most felt they were very special to have this chance to go behind the scenes at an AFOL event. My fingers are crossed that this brilliant idea is adopted by other organized gatherings in the future.

Some of the other event highlights from the perspective of this starry-eyed wannabe builder were the seminars offered that weekend. I opted to attend only a few of the many fascinating discussions but am so pleased with what I saw. My favourite was a talk by LEGO employees Kelly McKiernan and Pierre Normandin about their transition from working a regular job (like the rest of us) to having every LEGO fan's dream job in Billund, Denmark. Who wouldn't enjoy an insight into this much sought after career? I certainly was not disappointed as they led us through images of their new home in 'The Motherland'. I had long understood that the birthplace of LEGO was a small town, but as I studied the aerial photographs I was astounded to see that it isn't just small, it's downright tiny! You can actually very easily walk everywhere that you want to go! I was also impressed with some of the more quirky nuggets of trivia brought up by Melody Caddick who shared some surprising photos of the Billund landscape. For instance, it seems that the LEGO designers did not have to look far for the inspiration to create some of the elements





we all know and love. The Danish landscape is dotted with real life examples of classic LEGO parts. Shutters, doors and even cars from the streets of Billund seem to have found worldwide fame by being recreated in ABS plastic. I certainly never realized that these iconic parts were modelled after real architectural features.

Unfortunately, all good things must end and the weekend went by all too fast. But surprisingly the best moment of the convention for me happened once the fest was officially over. When the hall was emptied and all the clean-up finished, a motley collection of about twenty attendees joined together back at our hotel. I was so pleased to be included as many of the people I admire most were in the group. Barely a minute after settling into the uncharacteristic yet welcome quiet of the darkened lounge atop the Red Lion we were approached by a curious onlooker wanting to know what our group was, "all about". When it was explained to him that we were AFOLS he became quite enthusiastic and praised heartily the coolest LEGO creation he had ever seen; an incredible full scale model of a car in Beaver Creek, Colorado. Imagine his surprise as right beside him LEGO Model Designer Erik Varszegi casually asserted, "yeah, I did that". It was then that I looked around the table and realized with awe that assembled here was an incredible array of influential LEGO builders, fans and employees. Through sheer happenstance this lucky fellow had at his sole disposal an accumulation of LEGO knowledge and experience that any reader of this publication would give their eye teeth to enjoy in person. But it was his next question that struck me most. He asked simply, "So what I really want to know is, what's the best thing that you can build with LEGO?" Without hesitation and with utter conviction LEGO Universe Lead Jim Foulds spoke the words that still resonate with me, "The *best* thing you can build with LEGO is friendship." 



Model

Building Secrets

From The Masters



Ever wanted to build like the Pros?

Let Model Building Secrets show you how! Check out "How to Build a Round Ball with Square Bricks!" The first in a new series of books that teach you how to build just like the Master Model Builders. Created by Mariann Asanuma, a former Master Model Designer at LEGOLAND California.



www.modelbuildingsecrets.com





Oct 1st-4th, Seattle Center Exhibition Hall

BRICKFAIR 2009

DC LEGO Fan Festival

Tyson's Corner, Virginia
August 21-23, 2009

- ⊕ 20,000+ square feet of MOCs
- ⊕ Door prizes
- ⊕ Building contests
- ⊕ Charity auction
- ⊕ LEGO fun and games
- ⊕ Brickfilms
- ⊕ Trophies
- ⊕ LEGO vendors
- ⊕ Robot wars
- ⊕ And more!



**THREE DAYS OF LEGO...
A YEAR'S WORTH OF FUN!**

www.BrickFair.com

For each public visitor, BrickFair will donate \$1 to the SladeChild Foundation (www.SladeChild.org).

LEGO History

From the Idea House



Building the DUPLO Brand

*Article by Inge Aaen
Photography Courtesy the
LEGO Idea House*

Celebrating 40 years of the DUPLO brick

This year – 2009 – marks 40 years since the legendary LEGO DUPLO brick was launched internationally. Since the launch, “the big bricks for small hands” have continued to move with the times, providing fun for youngsters again and again.

Building blocks of child’s play

DUPLO bricks are designed to provide endless fun – first through building, then role playing. And each time they can be made into a new building, providing a new play experience. It’s more than just fun ... this type of play aids child development offering opportunities to improve hand-eye co-ordination and motor skills, learn color recognition, nurture creativity and build self esteem. Plus, it encourages parent and child interaction through building and playing.

How did it all begin?

The story of how the LEGO Group developed the DUPLO element begins way back in the early 1960s. Denmark is in the midst of a boom. Affluence powers the growth process, and consumer spending is at an all-time high. In the Swinging Sixties, Denmark metamorphoses into an industrial nation.

We say goodbye to production of wooden toys after the factory fire in 1960 to concentrate on development of the LEGO System of Play.

Following the successful launch of LEGO bricks in 1958, it becomes obvious that a bigger brick is needed to allow younger children to join in the fun and experience its developmental benefits.

Responding quickly to signals from the market

In 1961 the company launches its first institutional range in Denmark – therapy sets I, II & III. Work on the kindergarten range inspires development of a larger size of brick. A group of visiting kindergarten teachers spot some large experimental bricks – and expressed their enthusiasm to LEGO Owner Godtfred Kirk Christiansen.

In the same year the LEGO Group signs a 99-year sales and manufacturing licensing agreement with the American luggage group, Samsonite Corporation, covering production and marketing of LEGO products in the American and Canadian markets. In 1963, representatives of the Samsonite organisation visit the Billund factory. They are very interested in some prototype 8-stud bricks that the developers are experimenting with. The dimensions are 4” x 2” x 1” (99.7 x 49.7 x 25 mm excl. stud height).

Kindergarten bricks – LEGO JUMBO bricks

In early 1964 our representatives visit the Samsonite Corporation, LEGO Division, Denver, Colorado, in the USA. They receive an order for 900 of the large bricks – 300 each in red, white and blue – for delivery as soon as possible. On February 25, 1964, the red, white and blue Kindergarten bricks are shipped from Denmark.

Samsonite wants to buy moulds for the production of JUMBO bricks as they become known on the American and Canadian markets. Drawings for the first mould are dated March 12, 1964. In Canada, LEGO JUMBO bricks are marketed until 1970, in the USA until 1971. (The licensing agreement from 1961 ends in 1972.)

“Big bricks for small hands”

As LEGO FUTURA, the LEGO Group’s development unit (set up in 1965) turns its attention more specifically to product development, attention turns to the big bricks. The age of the child is the main segmentation criterion. The view is: “There is no other toy which seriously covers a longer part of the child’s play age.”

The ambition is for the large bricks – as opposed to the JUMBO bricks – to be an enlarged version of the standard brick. To this end, prototypes are produced on scales of 2:1, 3:1 and 4:1. The latter variation is never produced and marketed but 3:1 (three times as long, wide and high as an ordinary 8-stud LEGO brick) is test-marketed in some European markets as art.nos. 501, 502 and 503 in 1966-67.

LEGO JUMBO Brick #502, released as a test in Europe.



This set contains 60 snap-together Jumbo Size (1" x 2" x 4") Lego Bricks. They come in three colors: 20 each of red, blue and white, packed in a sturdy, reusable double-strength container.

- Specially Designed for Children from Nursery School Through First Grade**
 Lego Jumbo Bricks are ideally suited for little hands and young minds. The picture to the right, in actual size, shows a jumbo brick in a child's hand. With only one size brick and just three colors to choose from, the child is encouraged to build simpler models, so he can easily recognize what he is attempting to create.
- Lego Plays an Important Role in the Curriculum**
 When properly used in your classroom, Lego Jumbo Bricks can: (a) Help to develop eye-hand coordination. (b) Provide props for story telling and other language arts activities. (c) Aid in developing size and shape discrimination. (d) Stimulate creative role playing. (e) Strengthen concepts of balance, height and distance.

Actual Size



Top and above: LEGO JUMBO Bricks advertising and packaging (Samsonite).

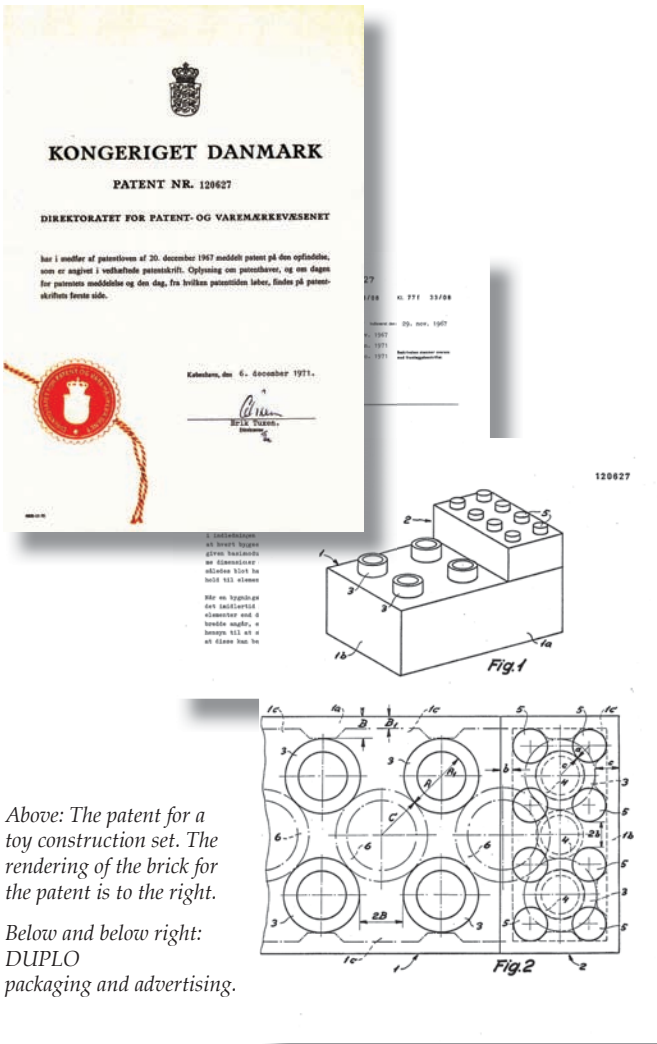

Above: The patent for a toy construction set. The rendering of the brick for the patent is to the right.

Below and below right: DUPLO packaging and advertising.

The perfect fit

The key challenge is for any new brick to work with the LEGO building system, to ensure consistency and product longevity. The system principle requires the ability to interlock with the smaller, standard bricks. And the various kindergarten bricks have flat, solid studs. There are many experiments, and numerous manual specimens are made on a scale of 2:1. The problem is solved by Godtfred Kirk Christiansen - the LEGO System's creator - who literally dreams up the answer in his sleep: By hollowing out the stud, it is possible to plug the standard LEGO brick tube into the hollow DUPLO projection.

DUPLO brick is born - November 29, 1967

Each dimension of the DUPLO brick is exactly twice that of the standard LEGO brick and the studs are hollow, enabling LEGO bricks to interlock perfectly with DUPLO bricks. This construction method of interlocking large and small elements with each other was quickly patented.

A patent is granted for a toy construction set on November 29, 1967. (A patent is not granted for DUPLO on its own - the name DUPLO isn't mentioned in the patent documents.)

1969 International launch

In 1968 DUPLO bricks are first tested in Sweden and modifications are made to improve the interlocking feature before the launch on international markets in 1969 as article nos. 510 and 511.

Packaging demonstrates the building system. Consumer information emphasizes this interlocking feature. In the early stages, it is expressed as an equation. Modifications and adjustment of the DUPLO brick's dimensions continue. **h**

Find out more about DUPLO in our next issue!



What do you build with LEGO bricks?

It's a question that seems to be a subtext in many of the articles in this issue. While we are used to seeing stories on builders and info about sets and their design, there are also some other stories about building other things.

In the Middle East, the LEGO brick and NXT brick both built the framework to many friendships and a budding community. In Raleigh, North Carolina (my hometown), the LEGO brick was used to help plan the region's future. In Japan, the LEGO brick was used to build a tower, and a couple of books, much like *BrickJournal*.

There's other examples that *BrickJournal* will be looking at in later issues - community programs, FIRST LEGO League, and more. I, as the editor to this publication, have been able to see many different ways that the brick has been used to build, to create, and to communicate.

So I ask you, the reader: What do you build with LEGO bricks?

If you think about it, you'll realize it's much more than just MOCs. 

Joe Meno
Editor

PS - See you soon - we are now BIMONTHLY! Full speed ahead!!

Last Word



ALERT!! FOR READERS WHO PURCHASE *BRICKJOURNAL* AT COMIC BOOK STORES:

This is the **LAST** issue that you will be able to buy from comic book shops—their distributor has decided to stop carrying *BrickJournal*. (You can still get our *Compendiums* there, though.)

BrickJournal is still available at select Barnes and Noble bookshops and also at the LEGO Brand Retail stores in the US, as well as at LEGOLAND California. And you can also still subscribe and buy back issues at www.twomorrrows.com, in both print and digital form!

An advertisement for 'Kaminoan's Fine Clonier Decals'. The background is a dark blue, futuristic scene with a large, glowing 'D' in the center. The text 'KAMINOAN'S FINE CLONIER DECALS' is prominently displayed in a stylized font. The website 'www.fineclonier.com' is in the top right. Below the text, five LEGO minifigures are shown: a red and white figure, a purple figure, a tan figure holding a pink lightsaber, a red and white robot-like figure, and a grey figure. At the bottom, the text reads 'Kaminoan's Fine Clonier. For all your minifig decal customization needs.'

AFOLS

by Greg Hyland



Brick Journal

people • building • community



GET THE 9 ORIGINAL DIGITAL ISSUES!

**TAKE 50% OFF
COMPENDIUM 1 & 2
through July 31 at
www.twomorrows.com**

The first nine original issues of BRICKJOURNAL shown below comprise VOLUME ONE, and were released online from 2005-2007 as Digital Editions only. They're available in PDF form for downloading now for \$3.95 EACH, and #9 is FREE!



Those first nine digital-only issues that comprise Vol. 1 are finally available in **PRINT FORM FOR THE FIRST TIME** in our series of BRICKJOURNAL COMPENDIUMS! Each full-color trade paperback offers a wealth of information and building tips on all things LEGO! (NOTE: These are DIFFERENT ISSUES than the new ongoing print edition (Vol. 2)!

BRICKJOURNAL COMPENDIUM 1

COMPENDIUM 1 compiles the digital-only issues #1-3 (Vol. 1) of the acclaimed online magazine for LEGO enthusiasts of all ages — for the first time in printed form! It features interviews with LEGO car builder **ZACHARY SWEIGART** (showing his version of the time-traveling Delorean from the movie *Back to the Future*), **JØRGEN VIG KNUDSTORP** (CEO of LEGO Systems, Inc.), Mecha builders **BRYCE McLONE** and **JEFF RANJO**, paraplegic LEGO builder **SCOTT WARFIELD**, **BOB CARNEY** (LEGO castle builder extraordinaire) and **RALPH SAVELSBURG** (LEGO plane builder), **REVEREND BRENDAN POWELL SMITH** (author of the LEGO version of the Bible), NASA Astronaut Trainer **KIETH JOHNSON**, **JAKE MCKEE** (Global Community Director for The LEGO Group), builder **JASON ALLEMANN** on recreating the spacecraft from 2001: A Space Odyssey and 2010: The Year We Make Contact, features on the **BIONICLE** universe, how to make your own custom bricks, plus instructions and techniques, and more!

(256-page FULL-COLOR trade paperback) ~~\$39.95~~ US • ISBN: 978-1-893905-97-9
Diamond Order Code: FEB084083 • **50% OFF THRU JULY 31!**

BRICKJOURNAL COMPENDIUM 2

COMPENDIUM 2 compiles the digital-only issues #4-5 (Vol. 1) of the acclaimed online magazine for LEGO enthusiasts of all ages — for the first time in printed form! It features interviews with **MIKE WILDER** (about using a Mindstorms robot to film a 3-D documentary) and **MARK LARSON** (creator of the *Fabulous Housewives* online comic strip), **ALBAN NANTY** on his LEGO-based *Star Wars* film, plus features on LEGO character sculptures, tutorials on L-Cad software for creating projects, an examination of LEGOland's history, behind the scenes at a LEGO factory, building big with LEGOs (from castles and rollercoasters to ships and skyscrapers), creating custom minifigures, instructions and building techniques, and more!

(224-page FULL-COLOR trade paperback) ~~\$34.95~~ US • ISBN: 9781605490021
Diamond Order Code: JUN084416 • **50% OFF THRU JULY 31!**

BRICKJOURNAL COMPENDIUM 3

COMPENDIUM 3 compiles the digital-only issues #6-7 (Vol. 1) of the acclaimed online magazine for LEGO enthusiasts of all ages — for the first time in printed form! This FULL-COLOR book spotlights all aspects of the LEGO COMMUNITY through interviews with builders **KNUD THOMSEN** (builder of a LEGO city), **ANTHONY SAVA** (castle and dragon builder), **JØRGEN VIG KNUDSTORP** (CEO to the LEGO Group) and the duo **ARVO** (builders of many incredible models), plus features on LEGO FAN CONVENTIONS, such as **BRICKFEST**, **LEGO WORLD** (the Netherlands), and **1000STEINE-LAND** (Germany), reviews and behind the scenes reports on two LEGO sets (the **CAFE CORNER** and **HOBBY TRAIN**), how to create custom minifigures, instructions and techniques, and more! Edited by **JOE MENO**.

(224-page FULL-COLOR trade paperback) ~~\$34.95~~ US • ISBN: 9781605490069
Diamond Order Code: JAN094469 • **15% OFF AT www.twomorrows.com**

BRICKJOURNAL COMPENDIUM 4

COMPENDIUM 4 compiles the digital-only issues #8-9 (Vol. 1) of the acclaimed online magazine for LEGO enthusiasts of all ages — for the first time in printed form! It covers a LEGO art show, building a larger-than-life Yoda, an interview with LEGOland builder **GUY BAGLEY** and a top LEGO Star Wars set designer, how to build a **DROID STARFIGHTER**, a **LEGO POKÉMON** character gallery, a look at the **POWER FUNCTIONS** electric building system, a visit to an amazing **STAR WARS LEGO DISPLAY** in the United Kingdom, coverage of the 75th Anniversary celebration at the LEGO headquarters in Denmark, and more! Features LEGO event reports, building instructions and techniques, and more! Edited by **JOE MENO**.

(256-page FULL-COLOR trade paperback) ~~\$39.95~~ US • ISBN: 9781605490199
Ships November 2009 • **15% OFF AT www.twomorrows.com**



TwoMorrows. Celebrating The Art & History Of LEGO.™ (& Comics!)

TwoMorrows • 10407 Bedfordtown Drive • Raleigh, NC 27614 USA • 919-449-0344 • FAX: 919-449-0327 • E-mail: twomorrow@aol.com • www.twomorrows.com



NOT YOUR TYPICAL BRICKS

If you have seen THE engraved Brick Badges at BrickFest™ and other LEGO conventions, you have seen the work of Tommy Armstrong, the Brick Engraver. He can engrave names and line art directly to a brick, making it a unique item for things like keychains, badges, awards, and models.



If you're interested in seeing the wide assortment of brick engravings and finishes and now PRINTING that Tommy offers, you can go to www.brickengraver.com and browse through his catalog. You can see his work at events worldwide.

You'll see that his work is not typical. And neither are his bricks.

